

IA



OPERATOR'S MANUAL

SmartXide² TRIO

Code: OM103AE1_G.V03

S/N: UM8B4904Q

Manual Revision Date: 18/12/2018

DEKA
Innate Ability

DEKA M.E.L.A. s.r.l.
Via Baldanzese, 17
50041 Calenzano (FI) - Italy
Ph. +39 055 88.74.942
Fax +39 055 88.32.884



www.dekalaser.com

TABLE OF CONTENTS

| | |
|--|-----------|
| GLOSSARY | 1 |
| 1. INTRODUCTION | 3 |
| 1.1. The SmartXide²TRIO system..... | 3 |
| 1.2. About the Manual | 4 |
| 2. INDICATIONS FOR USE..... | 5 |
| 3. WARNINGS | 7 |
| 4. PREMISES..... | 9 |
| 4.1. Delivery – Inspection of goods received..... | 9 |
| 4.2. Working environment | 9 |
| 4.3. Responsibilities | 9 |
| 4.4. Laser Safety Officer..... | 9 |
| 5. SAFETY | 11 |
| 5.1. General safety..... | 11 |
| 5.2. Optical hazard | 11 |
| 5.2.1. Protective eyewear specifications | 12 |
| 5.3. Electrical Hazard..... | 12 |
| 5.4. Biological Hazard | 13 |
| 5.5. Fire Hazard..... | 13 |
| 5.6. Radio frequency interference | 13 |
| 5.7. Essential performances..... | 13 |
| 5.8. Safety labels | 14 |
| 5.8.1. Meaning of the safety labels | 15 |
| 5.8.2. Identification label | 16 |
| 5.8.3. Positions of the safety labels | 17 |
| 6. SYSTEM DESCRIPTION | 19 |
| 6.1. Control and signal devices | 20 |
| 6.1.1. System switches..... | 20 |
| 6.1.2. Footswitch | 20 |
| 6.1.3. Potential Equalization Connector | 20 |
| 6.1.4. Internal buzzer | 20 |
| 6.1.5. "SYSTEM READY" indicator..... | 21 |
| 6.1.6. Source status LED..... | 21 |
| 6.1.7. Active CO ₂ delivery system indicators | 21 |
| 6.1.8. Control panel | 21 |
| 6.3. CO₂ Laser Delivery Accessories..... | 22 |
| 6.3.1. Articulated arm | 22 |
| 6.3.2. Hollow waveguide (CO ₂ fiber) | 25 |

| | |
|--|-----------|
| 6.4. Diode laser delivery system and handpieces | 27 |
| 6.4.1. Diode handpieces for dental applications | 27 |
| 7. INSTALLATION | 29 |
| 7.1. System requirements | 29 |
| 7.1.1. Dimensions and weight | 29 |
| 7.1.2. Electrical requirements | 29 |
| 7.1.3. Environmental requirements | 29 |
| 7.1.4. System specifications | 30 |
| 7.1.5. Diode laser source (optional) | 32 |
| 7.2. Accuracy of values | 33 |
| 7.3. Installation | 34 |
| 7.3.1. Installation of the articulated arm's counterweight | 34 |
| 7.4. Hollow waveguide connection | 36 |
| 7.5. Fiber connection for diode source | 37 |
| 7.6. User ID chip | 38 |
| 7.7. Air flow connections | 39 |
| 7.8. Articulated arm working position | 40 |
| 7.9. Remote Interlock | 41 |
| 7.10. Moving/transporting the device | 42 |
| 7.10.1. Moving the device | 42 |
| 7.10.2. Transporting the device | 42 |
| 8. USE OF THE SYSTEM | 43 |
| 8.1. Starting up the system | 43 |
| 8.2. Management of the selected source | 44 |
| 8.3. User mode for CO₂ source | 45 |
| 8.3.1. CO ₂ Free Hand mode | 45 |
| 8.3.2. CO ₂ Fiber user mode | 48 |
| 8.4. User mode for diode source | 52 |
| 8.5. Favorite menu | 54 |
| 8.6. Database mode | 55 |
| 8.7. Set up menu | 58 |
| 8.8. CO₂ power calibration procedure | 59 |
| 8.9. System shutdown | 59 |
| 9. Scanning units | 61 |
| 9.1. Installation of the scanning unit | 61 |
| 9.2. Use of the HiScan Surgical unit | 63 |
| 9.2.1. HiScan Surgical alarms | 69 |
| 9.3. Use of the EndoScan unit | 70 |
| 9.3.1. EndoScan alarm | 73 |
| 10. CLINICAL APPLICATION | 75 |
| 10.1. CO₂ laser clinical application | 75 |

| | |
|---|-----------|
| 10.1.1. Contraindications..... | 75 |
| 10.1.2. Side effects | 75 |
| 10.1.3. Precautions | 76 |
| 10.1.4. Pretreatment Recommendations..... | 77 |
| 10.1.5. Treatment Recommendations..... | 77 |
| 10.1.6. Posttreatment Recommendations | 77 |
| 10.2. Diode laser module clinical applications | 77 |
| 10.2.1. General description..... | 77 |
| 10.2.2. Clinical applications | 78 |
| 10.2.3. Contraindications | 78 |
| 10.2.4. Collateral effects..... | 78 |
| 11. TROUBLESHOOTING | 79 |
| 11.1. Faults management..... | 79 |
| 11.2. Descriptions of Faults..... | 79 |
| 11.2.1. Interlock..... | 79 |
| 11.2.2. Temperature | 79 |
| 11.2.3. Shutter | 80 |
| 11.2.4. High voltage | 80 |
| 11.2.5. Flow | 80 |
| 11.2.6. High power/Low power..... | 80 |
| 11.2.7. EEPROM/Data Memory | 80 |
| 11.2.8. Diode fiber | 80 |
| 11.2.9. Ick Fiber..... | 80 |
| 11.2.10. High/Low Diode Temperature | 80 |
| 11.2.11. Diode Voltage/Diode Current/Diode Status | 81 |
| 11.2.12. High/Low Diode power | 81 |
| 11.2.13. Communication | 81 |
| 11.2.14. Driver..... | 81 |
| 11.2.15. High/Low driver temperature | 81 |
| 11.2.16. Diode controller..... | 81 |
| 11.2.17. CO ₂ PS TEMP | 81 |
| 11.2.18. CO ₂ Power Supply..... | 81 |
| 11.2.19. CO ₂ DUTY..... | 81 |
| 11.2.20. Flip Mirror | 81 |
| 11.2.21. High Fiber Temperature | 81 |
| 11.2.22. Air Pressure..... | 82 |
| 11.2.23. FIBER..... | 82 |
| 11.3. Warnings..... | 82 |
| 11.4. Troubleshooting | 82 |
| 12. MAINTENANCE..... | 83 |
| 12.1. Ordinary maintenance | 83 |
| 12.1.1. Laser Care and Handling | 83 |

| | |
|--|-----------|
| 12.1.2. CO ₂ reusable parts reprocessing | 83 |
| 12.1.3. Diode reusable parts reprocessing | 85 |
| 12.1.4. Inspect, clean and disinfect the scanning units | 87 |
| 12.1.5. Inspecting the diode fiber | 87 |
| 12.1.6. Fiber care | 88 |
| 12.1.7. Antibacterial filter check and cleaning..... | 88 |
| 12.1.8. Air filters cleaning | 89 |
| 12.1.9. Emergency switch and interlock | 89 |
| 12.2. Disposal of system..... | 89 |
| 12.3. Maintenance to be carried out by skilled personnel..... | 89 |
| 13. ACCESSORIES | 91 |
| 14. APPENDIX A..... | 95 |
| 15. APPENDIX B..... | 99 |
| 15.1. Internal power meter calibration | 99 |

INDEX OF FIGURES

| | |
|---|----|
| Fig.1 - Door safety label | 11 |
| Fig.2 - Safety labels..... | 14 |
| Fig.3 - Identification label..... | 16 |
| Fig.4 - Position of the safety labels | 17 |
| Fig.5 - System’s main external components..... | 19 |
| Fig.6 - Display adjusting keys..... | 21 |
| Fig.7 - Laser handpiece..... | 22 |
| Fig.8 - Positioning of the smoke evacuator hose on the system | 23 |
| Fig.9 - Assembling the handpieces..... | 23 |
| Fig.10 - 5" handpiece and spacers..... | 24 |
| Fig.11 - 8" handpiece and spacers..... | 24 |
| Fig.12 - 2" CO ₂ dental handpiece..... | 25 |
| Fig.13 - Hollow waveguide and handpiece..... | 25 |
| Fig.14 - Diode laser handpiece with cannulas and fiber | 27 |
| Fig.15 - Diode dental handpiece | 27 |
| Fig.16 - Inserting the fiber optic into the handpiece | 28 |
| Fig.17 - Connecting the tip..... | 28 |
| Fig.18 - Installation of the articulated arm’s counterweight..... | 35 |
| Fig.19 - Counterweight | 35 |
| Fig.20 - Hollow waveguide connection | 36 |
| Fig.21 - Fiber, handpiece and cannula..... | 37 |
| Fig.22 - Connecting the fiber to the system | 37 |
| Fig.23 - "User ID" key socket..... | 38 |

| | |
|--|----|
| Fig.24 - "User ID" icon in the User menu | 38 |
| Fig.25 - Air flow connector on system | 39 |
| Fig.26 - External air flow connector on system | 39 |
| Fig.27 - Articulated arm working position | 40 |
| Fig.28 - Proper resting position of the arm | 40 |
| Fig.29 - How to open the interlock connector..... | 41 |
| Fig.30 - Home menu..... | 43 |
| Fig.31 - CO ₂ Free Hand mode..... | 45 |
| Fig.32 - CO ₂ Free Hand mode..... | 45 |
| Fig.33 - Exposure mode selection | 47 |
| Fig.34 - CO ₂ Fiber user mode | 48 |
| Fig.35 - "Air flow" menu for CO ₂ Fiber..... | 50 |
| Fig.36 - Diode Free Hand mode | 52 |
| Fig.37 - Diode exposure modes - examples | 53 |
| Fig.38 - 'Add to favorites' menu..... | 54 |
| Fig.39 - Summary of parameter values to be saved | 54 |
| Fig.40 - Loading a parameter set from list of favorite parameter sets..... | 55 |
| Fig.41 - Database mode..... | 55 |
| Fig.42 - ENT treatments | 55 |
| Fig.43 - Keyboard..... | 56 |
| Fig.44 - Database filter..... | 57 |
| Fig.45 - How to save a treatment | 57 |
| Fig.46 - "Set up" menu | 58 |
| Fig.47 - Connection of the scanning unit | 61 |
| Fig.48 - HiScan Surgical unit..... | 63 |
| Fig.49 - User menu when HiScan Surgical unit is activated | 63 |
| Fig.50 - Curving parameter | 64 |
| Fig.51 - Selection of the exposure mode..... | 65 |
| Fig.52 - "No Scan" mode | 67 |
| Fig.53 - "Settings" option..... | 67 |
| Fig.54 - EndoScan unit..... | 70 |
| Fig.55 - User menu when the EndoScan unit is activated | 70 |
| Fig.56 - EndoScan centering correction | 72 |
| Fig.57 - "SYSTEM FAULT" menu..... | 79 |
| Fig.58 - Disassembling the CO ₂ handpieces..... | 84 |
| Fig.59 - Disassembling the diode handpiece | 86 |
| Fig.60 - Disassembling the diode dental handpiece | 86 |
| Fig.61 - Scoring the fiber | 88 |
| Fig.62 - Air filters replacing | 89 |

INDEX OF TABLES

| | |
|---|----|
| Table 1 - Symbols and abbreviations | 1 |
| Table 2 - Units of measurement..... | 2 |
| Table 3 - Meaning of the safety labels | 15 |
| Table 4 - Dimensions and weight..... | 29 |
| Table 5 - Operating and environmental conditions..... | 30 |
| Table 6 - Transport and storage conditions..... | 30 |
| Table 7 - System specifications..... | 30 |
| Table 8 - CO ₂ laser source emission features | 30 |
| Table 9 - Specifications for the aiming source of CO ₂ laser | 31 |
| Table 10 - Operating characteristics | 32 |
| Table 11 - Diode laser source features | 32 |
| Table 12 - Specifications for the aiming source of diode laser:..... | 33 |
| Table 13 - Diode fiber characteristics | 33 |
| Table 14 - Diode source operating characteristics..... | 33 |
| Table 15 - Power and Frequency selection in DP mode | 46 |
| Table 16 - Minimum available TON according to selected frequency..... | 47 |
| Table 17 - Power and Frequency selection in DP mode | 49 |
| Table 18 - Minimum available TON according to selected frequency..... | 49 |
| Table 19 - Accessories | 91 |
| Table 20 - F26201 diode laser accessories (if included) | 94 |
| Table 21 - F262A1 diode laser accessories (if included)..... | 94 |
| Table 22 - Optional accessories for diode laser module..... | 94 |

GLOSSARY

The following symbols and abbreviations may be used on the system and/or in this manual.

Table 1 - Symbols and abbreviations





| | |
|--|-------------------------------------|
|  | Symbol for "Date of Manufacture" |
|  | Symbol for "Manufacturer" |
|  | Electrical protection degree type B |
| I | Electrical protection type |
| ~ | Symbol of alternating current |
|  | Warning on system discarding |
|  | Refer to the Instructions for Use |
| REF | Catalogue number |
| SN | Serial number |
| NOHD | Nominal Ocular Hazard Distance |
| ON/OFF | Use/Pause: intermittent use cycle |

Table 2 - Units of measurement

| | |
|----|--|
| J | Joule - unit of energy |
| mJ | millijoule - 1000mJ=1J |
| nm | nanometer - unit of laser wavelength, 1000nm=1µm |
| µm | micrometer - 1000000 µm=1m |
| s | second - unit of time |
| µs | microsecond - 1000000µs=1s |
| ns | nanosecond - 1000ns=1µs |
| Hz | Hertz (cycles per second) - unit of frequency |
| A | ampere - unit of electrical current |
| VA | volt ampere - unit of absorbed electrical power |
| V~ | unit of alternating voltage |
| Pa | Pascal - unit of measure of atmospheric pressure |

1. INTRODUCTION

1.1. The SmartXide²TRIO system

The SmartXide²TRIO system consists in a 10,600nm carbon dioxide laser (CO₂) laser with 60W of maximum power.

As scientifically entirely known, the 10,600nm wavelength is mostly absorbed by water; this characteristic makes this laser particularly suitable for soft tissue surgery.

CO₂ laser surgery is well recognized to be minimally invasive and highly effective, as proven by the hundreds of scientific articles written on this kind of laser in surgery and microsurgery in various disciplines and districts for more than 20 years.

The SmartXide²TRIO system is designed to deliver the CO₂ laser beam both through articulated arm (handpieces and scanning unit) and both through hollow waveguide (CO₂ fiber).

The scanner technology (HiScan Surgical) can be used for surgical applications coupled with microspot micromanipulators for microsurgery applications in ENT, gynaecology and neurosurgery.

Another scanner, a miniaturized one, the EndoScan, is connectable with the SmartXide² TRIO system. This scanning unit is suited mainly for gynecological application both in colposcopic and laparoscopic procedures, but also for other surgical applications in which quick ablation is needed.

The system can be provided (optionally) with a diode laser source of 50W maximum power.

The diode module can be chosen by the customer in two alternative wavelengths: 980nm and 940nm. Compared to the CO₂ laser, diode lasers are less absorbed by water and more by hemoglobin and melanin; for this reason they are used in applications of anatomic districts that need a more coagulative power. Moreover they have the possibility of being delivered by optical fibers thus allowing them to be used in body parts difficult to reach in open, rigid, or flexible endoscopic applications.

CAUTION: Federal (USA) law restricts this device to sale by or on the order of a physician or other practitioner licensed by the law of the state in which he/she practices to use or order the use of the device.

Federal law and some international laws also require that this device be utilized under the direction of a physician. This device should only be used by healthcare professionals authorized under US state or international laws to treat patients. All persons treating patients with this device should determine whether they are authorized healthcare professionals under the applicable US state or international laws.

1.2. About the Manual

The SmartXide²TRIO Operator's Manual provides operators with the following information about the system:

- Indications for use
- Safety
- System description
- Installation
- Use of the system
- Scanning units
- Clinical Applications
- Faults and troubleshooting
- Maintenance
- Accessories

Before using the system for the first time, please familiarize yourself with the information and instructions of this manual. This is essential to ensure an effective and optimal use of the system, to avoid damage to people or to the device and to obtain good results of treatment.

In this manual we use different colours to highlight warnings:

- warnings on a grey background are remarks for a correct use of the system and of its accessories;
- warnings on a grey background and with a yellow triangle are remarks concerning safety.

Operators must read and follow all the remarks.



CAUTION - Possible risk for patient/operator

The use of controls or adjustments, or performance of procedures other than those specified herein may result in hazardous laser radiation exposure.

2. INDICATIONS FOR USE

The SmartXide²TRIO system with its accessories is a medical device indicated for:

- **CO₂ laser source:** incision, excision, ablation, vaporization and coagulation of body soft tissues, in medical specialties including aesthetic (dermatology and plastic surgery), podiatry, otolaryngology (ENT), gynaecology, neurosurgery, orthopaedics, general and thoracic surgery (including open and endoscopic), dental and oral surgery, and genitourinary surgery.
- **940nm diode laser source:** incision, excision, vaporization, ablation and coagulation of soft tissues (open surgery), cutting, vaporization, ablation and coagulation of soft tissues (endoscopic surgery) in medical specialties including: plastic surgery, dermatology, ENT, gynaecology, urology, general surgery, gastroenterology and dental procedures.
- **980nm diode laser source:** incision, excision, vaporization, ablation and coagulation of soft tissues (open and endoscopic surgery) in medical specialties including: plastic surgery, dermatology, ear, nose and throat and oral surgery (otolaryngology), gynaecology, urology, neurosurgery, general and thoracic surgery, gastroenterology and dental procedures.

The device is not indicated to be used for Prostate Ablation procedure.



CAUTION - Possible risk for patient/operator

The SmartXide² TRIO system must not be used for applications other than those specified above.

DEKA M.E.L.A. s.r.l. is not responsible for direct or side effects resulting from use of the system differing from the intended use specified above.



CAUTION - Possible risk for patient/operator

DEKA M.E.L.A. s.r.l. is not liable for direct or indirect effects arising out, in connection with or resulting from the application or use of the system, which are not a direct consequence of design or manufacturing defects of the device or parts thereof.

The manufacturer shall not be responsible of the success of the treatment.

Page intentionally left blank.

3. WARNINGS

This manual is not intended to be a complete guide to the use of the system.

DEKA M.E.L.A. s.r.l. recommends that all users first seek training that includes, but is not limited to, the following aspects of operation:

- Basic Laser Energy Physics
- Laser Safety
- Tissue Interaction
- Operating Procedures
- System Set-Up Procedures
- Potential Hazards

DEKA M.E.L.A. s.r.l. shall not be liable nor responsible of the safety and performance in the following cases:

- if the system is not used in compliance with health and safety rules and regulations in force;
- if the precautions and instructions contained in the present manual are not observed;
- if the system is not used by qualified and trained personnel;
- if the installation, any modification, recalibration or maintenance are not performed by qualified personnel authorised by DEKA M.E.L.A. s.r.l.;
- if the environment in which the system is located and used does not conform with all electrical, laser, etc. safety prescriptions specified by the applicable international and local regulations and international guidelines in force.

DEKA M.E.L.A. s.r.l. reserves the irrevocable right to provide, upon written request, maintenance personnel authorised by the same, with electrical diagrams, components lists, adjustment instructions and any information relating to the parts of the system which are considered to be repairable.

Do not modify this equipment without authorization of DEKA M.E.L.A. s.r.l.

Page intentionally left blank.

4. PREMISES

The following instructions must be scrupulously observed.

4.1. Delivery – Inspection of goods received

Unless otherwise agreed between the manufacturer and the customer, the delivery of the goods shall be ex works (INCOTERMS 2000) even if it has been expressly agreed that the transport or part thereof shall be the responsibility of the manufacturer on the customer's behalf.

Upon delivery, all risks inherent to the system shall be transferred to the customer. Therefore, any damage to the system during transport shall be to the customer's account.

It shall be the customer's responsibility to inspect upon delivery and in the presence of the carrier, the integrity and condition of the goods received; to verify correspondence between the goods delivered and those described in the transport documentation; to immediately bring to the carrier's attention any divergence and/or damage noticed.

4.2. Working environment

The environment in which the device is located and operated must be suitable and comply with the relative legal requirements and regulations in force, applicable also to the associated systems, concerning the use and storage thereof in complete safety to persons and objects. The operation, workplace health and safety measures and any other activities shall be the exclusive responsibility of the relevant person(s) in charge and must be performed in compliance with local laws and Regulations and, where applicable, in compliance with European Directives (Council Directive 89/391/EEC and subsequent).

4.3. Responsibilities

The manufacturer shall guarantee the conformity of the product with EC safety and hygiene requirements according to the applicable Directives.

The use of the system shall be the exclusive responsibility of the operator who shall be obliged to apply the necessary and adequate diligence and skills.

The manufacturer shall be responsible in terms of and within the exclusive scope of current regulations applicable to the production and marketing of medical devices.

The manufacturer shall not be responsible for unfavourable consequences resulting from installation, use or maintenance which does not comply with the instructions in the present manual or resulting from failure by the user to apply the care, precautionary measures and safety regulations necessary to avoid such consequences.

4.4. Laser Safety Officer

We recommend prior consultation of the IEC TR 60825-8 Safety of laser products, Part 8: Guidelines for the safe use of laser beams on humans (2006-12, Second edition), which is a guideline on how to apply laser safety in medical practices.

In accordance with Point 3.1 of the above mentioned guidelines, we recommend that a Laser Safety Officer be appointed and a precise definition of the relative responsibilities established.

Page intentionally left blank.

5. SAFETY

This chapter provides a short description of the current safety standard taken in account while designing and manufacturing the SmartXide² TRIO system.

This section also covers specific safety features designed to minimize potential hazards.

5.1. General safety

The SmartXide²TRIO system is compliant with, but not limited to, the following standards:

- **Standard IEC 60601-1** - Medical electrical equipment Part 1: General requirements for basic safety and essential performance
- **Standard IEC 60601-1-2** - Medical electrical equipment – Part 1: General requirements for basic safety and essential performance - Collateral standard: Electromagnetic disturbance – Requirements and tests
- **Standard IEC 60601-2-22** - Medical electrical equipment - Part 2-22: Particular requirements for basic safety and essential performance of surgical, cosmetic, therapeutic and diagnostic laser equipment
- **Standard IEC 60825-1** - Safety of laser products - Part 1: Equipment classification and requirements

Classification:

- According to Standard IEC 60601-1, the SmartXide² TRIO system is classified as “**Class I**” with regard to the type of electrical protection, and “**type B**” for the degree of electrical protection.
- According to Standard IEC 60825-1, the SmartXide²TRIO system is in **Class 4**.

5.2. Optical hazard

The SmartXide²TRIO system emits a visible/invisible beam of intense energy that can cause serious eye and skin injury with direct or indirect beam contact. Please adhere to the following precautions to minimize optical damage to operators, assisting personnel and patients:

- All persons in the room during treatment must wear **protective eyewear**. See next paragraph for protective eyewear specifications.



CAUTION - Possible risk for patient/operator

- **Never look directly into the handpiece, into the fiber or into apertures labelled “laser aperture”, even while wearing protective eyewear.**
- **Limit entry to the treatment room to only those who assist in treatment and are trained in the use of the equipment.**

- Mark treatment rooms clearly to avoid unexpected entry during treatment.

The label shown in Fig.1 must be put on the external part of each entrance to these areas in order to point out the presence of a laser source inside.



Fig.1 - Door safety label

Two of these labels are provided with the SmartXide² TRIO accessories.



CAUTION - Possible risk for patient/operator

- **Direct the activated laser only at the intended area of treatment.**
- **Remove any metal object such as watches, rings, necklaces and similar items from the operating area and, if possible, do not use reflective instruments or materials.**

Reflective objects could intercept the laser beam causing a deflection to an area other than the intended treatment area.

Many surfaces that may seem opaque can actually reflect the CO₂ or diode laser emission wavelength.

- Put the system into the Standby mode when not in use (when in Standby mode, the beam cannot be inadvertently activated).
- Ensure that all trained staff assisting in the treatment know how to shut down the system in the case of an emergency.
- **Always remove the key from the switch when the system is switched off and keep it in a safe place.**

5.2.1. Protective eyewear specifications

Safety glasses must comply with the U.S. regulation ANSI Z136.7 "American National Standard for Testing and Labeling of Laser Protective Equipment".

The specifications for the safety glasses are then as follows:

- **CO₂ laser radiation:** OD• 4 @ 10600nm, DLB5 ILB5 @ 10600nm
- **Aiming diode laser radiation:** OD≥1 @ 635nm;
- **Diode laser radiation:** OD≥4, DLB6 @ 930-990nm.

Contact your area agent or DEKA M.E.L.A. s.r.l. company for information on where to find this type of eyewear.



CAUTION - Possible risk for patient/operator

- **As a safety precaution, eyes must not be exposed to direct laser radiation, even if protected by glasses.**
- **Safety glasses for CO₂ laser radiation are different from those for diode laser radiation and must not be exchanged.**
Always check you are wearing the right goggles: verify that the wavelength of the source you are using is marked on the lens or on the frame.

5.3. Electrical Hazard

The SmartXide²TRIO system uses high voltages internally. Do not open the protective panels unless trained and authorized to do so.



CAUTION - Possible risk for patient/operator

To avoid the risk of electric shock, this device must only be connected to supply mains with protective earth.

5.4. Biological Hazard



CAUTION - Possible risk for patient/operator

**The laser smoke presents a possible biological hazard. Ablated tissue from the patient is contained in the smoke.
Laser smoke may contain viable particles. The use of a laser smoke evacuator is recommended.**

5.5. Fire Hazard

When the light or the laser beam contacts an exterior surface, that surface absorbs energy. This raises the surface temperature, whether the surface is skin, hair, clothes, or any flammable substance. Operators should take the following precautions to prevent a fire:

- Use non-flammable substances for such uses as anesthesia, preparing soft tissue for treatment, and cleaning or disinfecting instruments.
- Be especially careful with the use of oxygen. Oxygen accelerates both the severity and the extent of fire.
- Keep a minimum of combustible materials in the treatment room. If treatment requires the use of a combustible material, such as gauze, first soak it in water.
- Prevent singeing or burning when treating an area with hair by wetting the area with water or saline before beginning treatment.
- Always keep a small fire extinguisher and water in the treatment room.



CAUTION - Possible risk for patient/operator

**Never use inflammable gas as a gas shield.
The use of flammable anaesthetics or oxidizing gases such as nitrous oxide (N₂O) and oxygen should be avoided.
Some materials may be ignited by the laser equipment when saturated with oxygen, such as cotton wool. Solvents for adhesives and flammable solutions used for cleaning and disinfecting should be allowed to evaporate before the laser equipment is used.
It is also important to beware of the danger of ignition of endogenous gases.**

5.6. Radio frequency interference

The SmartXide² TRIO system complies with the EN 60601-1-2 standard. It needs special EMC precautions and needs to be installed according to EMC information provided in this manual - see Appendix -.

Portable and Mobile communication equipment can affect the SmartXide² TRIO system.

The SmartXide² TRIO system should not be used near other equipment.

If this is necessary, observe the SmartXide² TRIO to verify normal operation in the stacked configuration in which it will be used.

5.7. Essential performances

The following functions are Essential Performances, i.e. performances necessary to keep risk within acceptable limits:

- ability of the system to prevent any unwanted laser emission;
- ability of the system to stop laser emission as soon as footswitch is released;
- ability of the system to maintain laser output power during treatment within $\pm 20\%$ with respect to the set value.
- ability of the system to perform emission only from the selected source.

5.8. Safety labels

The SmartXide²TRIO system is provided with the safety labels shown in the following figure.

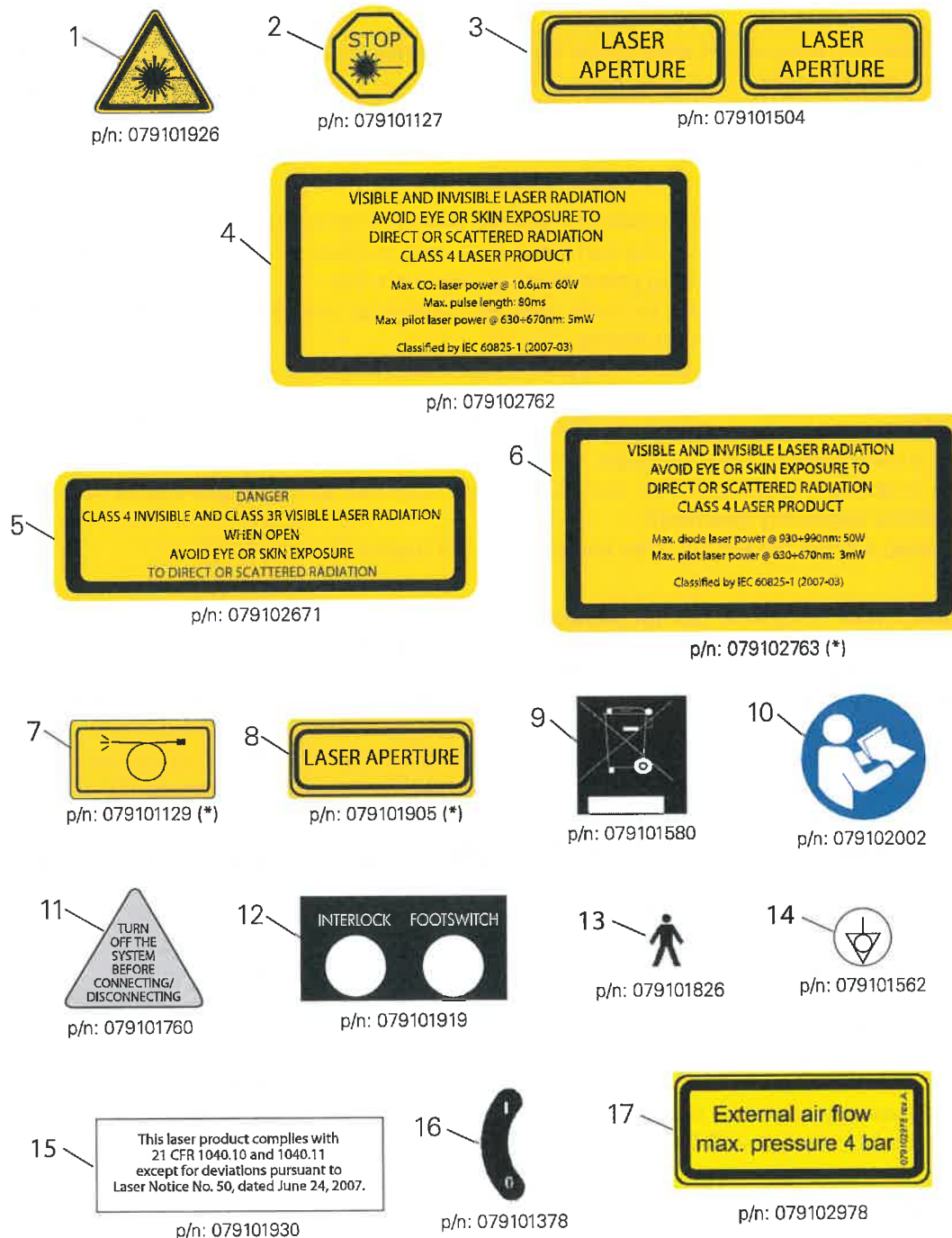

Fig.2 - Safety labels

(*) The SmartXide²TRIO system can be equipped also with a 50W diode laser source (*optional*). In this case, labels 6, 7 and 8 are also applied on the system.

5.8.1. Meaning of the safety labels

Table 3 gives the descriptions of the meanings of the safety labels shown in Fig.2.

Table 3 - Meaning of the safety labels

| Label Nr | Meaning |
|----------|--|
| 1 | Emission of laser radiation. |
| 2 | Identification of the emergency switch for fast system turn off. |
| 3 | Identifies the aperture from which laser radiation comes out. |
| 4 | Warning on dangers related to the exposure to laser radiation. Specifications on the characteristics of CO ₂ laser radiation. |
| 5 | Warning on dangers related to the exposure to laser radiation in case of removal of panels of the chassis. |
| 6 | Warning on dangers related to the exposure to laser radiation. Specifications on the characteristics of laser radiation of the diode source (<i>optional</i>). |
| 7 | Identification of the delivery system for diode laser radiation (<i>optional</i>). |
| 8 | Identifies the aperture from which diode laser radiation (<i>optional</i>) comes out. |
| 9 | Warning on system discarding. |
| 10 | Warning. The operator is recommended to read carefully the operator's manual before using the system. |
| 11 | Warning on scanning unit connection/disconnection. |
| 12 | Identification of the rear panel's (interlock and footswitch) connections. |
| 13 | Electrical protection degree type B. |
| 14 | Potential equalization connector label. |
| 15 | CDRH certification label. |
| 16 | Identification of the system key switch |
| 17 | Specification for pressure of external air flow. |

NOTE

All the labels must be kept in their own position, in good condition and immediately replaced if damaged.

5.8.2. Identification label

The device also bears a label containing system identification data, as shown in the figure below.



p/n: 079302488
(M103AE1)

Fig.3 - Identification label

5.8.3. Positions of the safety labels

The safety labels shown in Fig.2 and Fig.3 are placed as shown in the following figure.

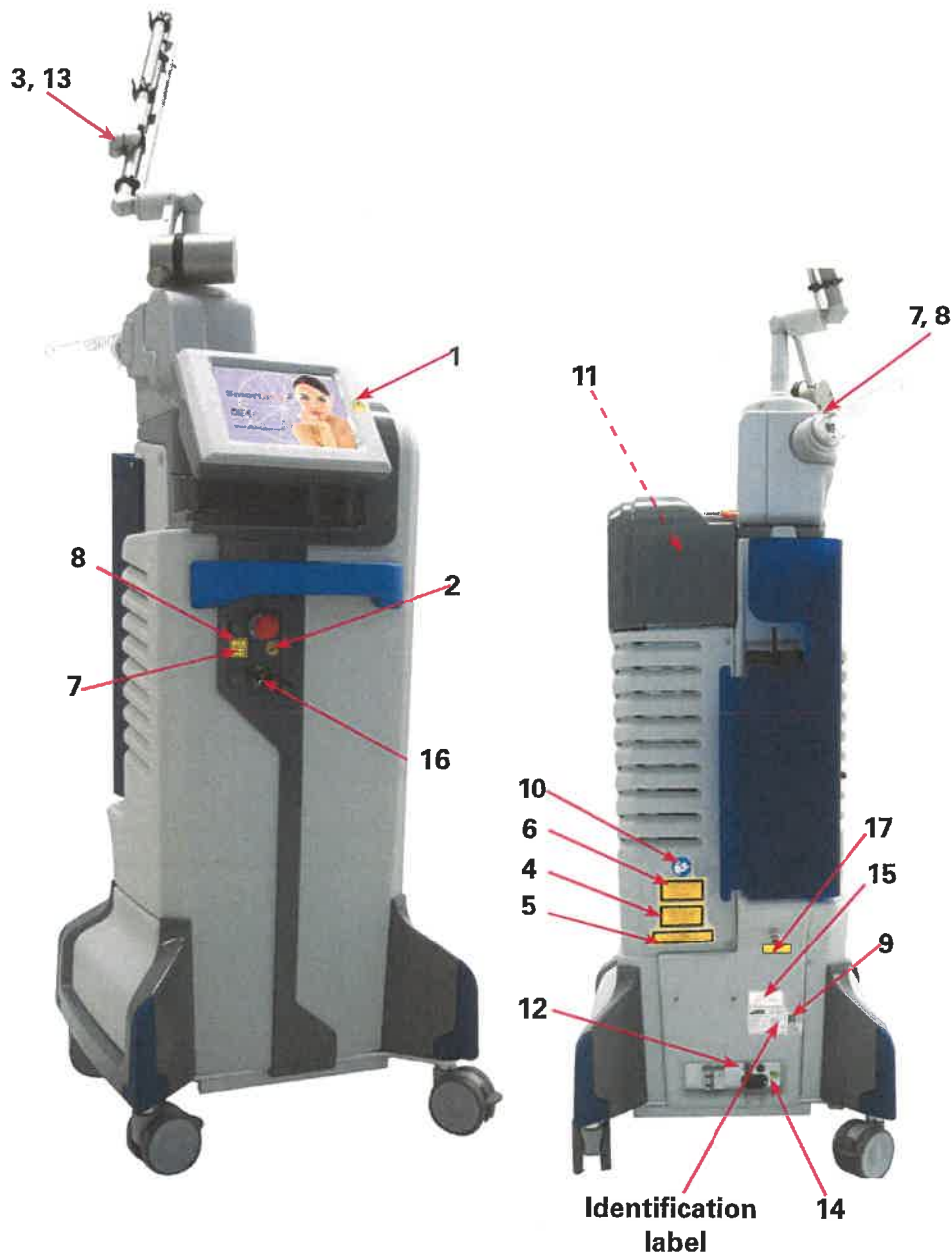

Fig.4 - Position of the safety labels

Page intentionally left blank.

6. SYSTEM DESCRIPTION

The operator interacts directly with the following external portions of the system.

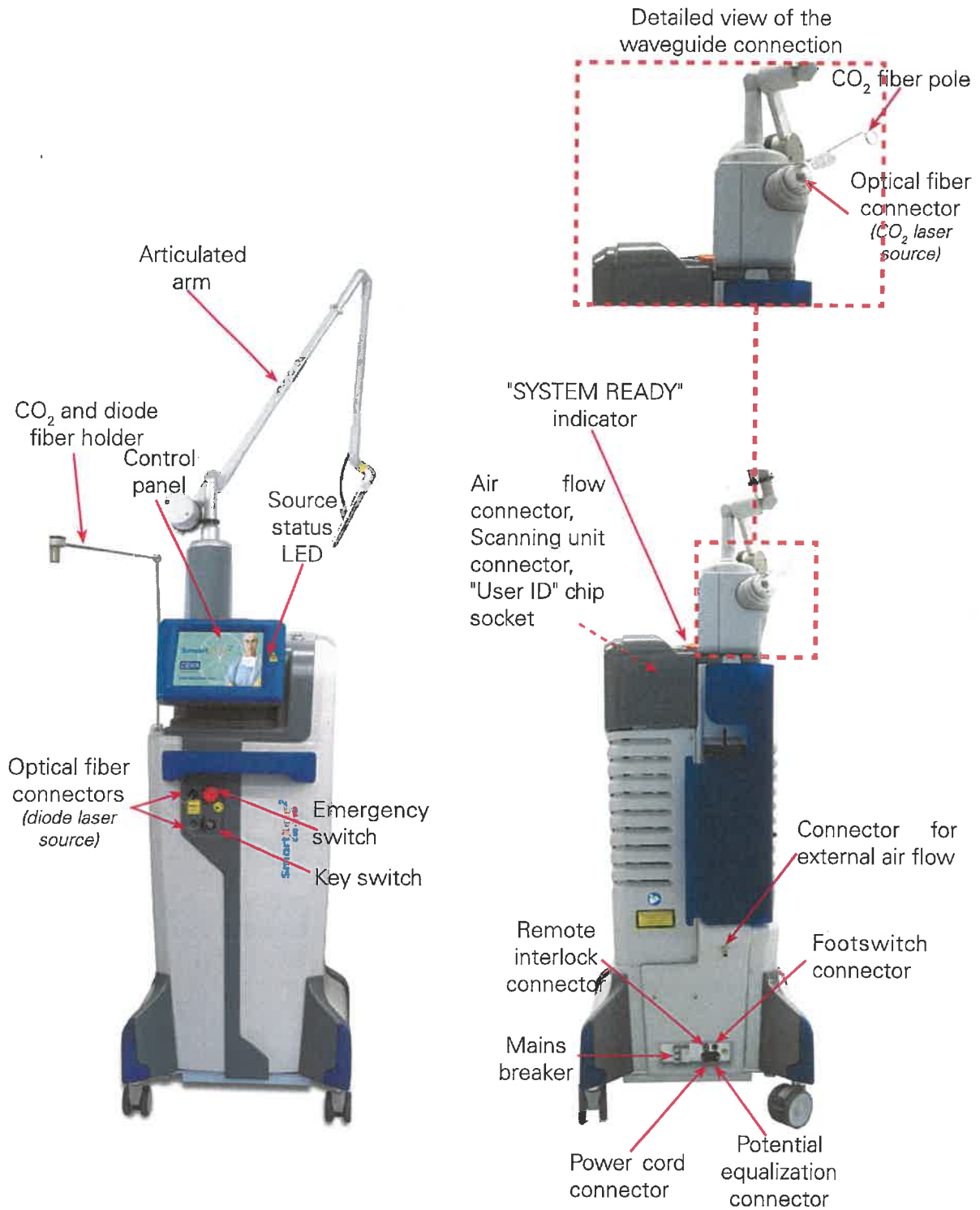

Fig.5 - System's main external components

6.1. Control and signal devices

6.1.1. System switches

The system power controls are comprised of the switches described in detail below. Please refer to Fig. 5 for their position on the device.

Key Switch

To turn the system on and off use the key switch.

It is a double-throw switch (right-left) with removable (only if it is in the "O" position) safety key.

To turn the system on, insert the key and turn the key switch to "I"; to shut the system down normally, turn the key to "O".

The key switch works to turn on the system only if the emergency switch is not pushed in.



CAUTION - Possible risk for patient/operator

The key must always be removed when the system is turned off and must be safely kept by authorized personnel only.

Emergency Switch

The emergency switch shuts down the system immediately.

Use it only under emergency circumstances that is in case it is necessary for the operator to stop immediately emission.

To shut down the system, push in the switch button. To reset the switch, rotate the button and pull out.

ATTENTION - Possible damage to the equipment

Do not use the emergency switch to turn the system on and off under normal circumstances.

Mains breaker

This switch is located on the bottom side of the rear panel.

Move towards left the lever of the switch (position "I") to supply the system.

6.1.2. Footswitch

When the system is in READY mode, activate the emission by pressing the footswitch, which is an electrical switch intended to be located on the floor and actuated by foot.

6.1.3. Potential Equalization Connector

The potential equalization connector is provided on the lower portion of the rear panel.

Connecting a potential equalization cable from this connector to an appropriately grounded connection in the operating room offers additional grounding of the laser system (potential equalization).

6.1.4. Internal buzzer

The system is equipped with an internal buzzer which produces an acoustic signal in the following cases:

- To warn the operator in case a wrong action has been performed - for instance, if footswitch is pressed when disabled -.
- If a laser treatment is in progress - CO₂ source switched on, footswitch enabled and pressed, shutter open, real power level correct - a sound is produced every 1s. This timed sound is intended to help the operator to 'measure' the treatment time.
- If a laser treatment is in progress - CO₂ source switched on, footswitch enabled and pressed,

shutter open, power level mismatch - five sounds are produced every 1s. This faster timed sound is intended to warn the operator that a power mismatch has been detected, that is the real CO₂ output power level no more matches with the power level found by the power evaluation procedure. See also par. 8.7.

6.1.5. "SYSTEM READY" indicator

The "SYSTEM READY" indicator (see Fig. 5) is lighted when the emission is enabled.

6.1.6. Source status LED

This LED (see Fig. 5) is blinking when the start up procedure is in progress, it is orange lit when the "ON"/"READY" status is set; it is red lit during emission. When the system is in stand by, the LED is green lit.

6.1.7. Active CO₂ delivery system indicators

These indicators show which CO₂ delivery mode is active:

- When the articulated arm delivery system has been selected, the indicator which encircles it will illuminate blue.
- When the hollow waveguide delivery system has been selected, the indicator which encircles the waveguide connector will illuminate blue.

6.1.8. Control panel

The control panel contains controls and displays for operating and monitoring the laser. It contains a rear-lit touch-screen graphic display. All the functional controls of the device can be set by lightly pressing an area of the screen itself. In order to have a better view, it is possible to adjust the display visual angle by pressing on the two keys next to the display itself (highlighted in Fig.6).



Fig.6 - Display adjusting keys



CAUTION - Possible risk for patient/operator

**Be very careful while the display is moving: do not keep your hands onto or near the display.
Danger of crushing!**

ATTENTION - Possible damage to the equipment

Please do not adjust the visual angle moving the display by hands!
Only electronic adjustment is allowed.

6.3. CO₂ Laser Delivery Accessories

6.3.1. Articulated arm

The handpieces shown in Fig.9, Fig.10, Fig.11 and Fig.12, and scanning units (see Section 9) are attached to the distal end of the articulated arm

The articulated arm is an optical assembly that delivers beam laser radiation. It is made up of seven mirrors placed on rotating knuckles: the mechanical accuracy of the articulated arm allows the CO₂ laser beam to travel inside it and along its axis however the arm is oriented.

The field of action of the articulated arm covers a radius of approximately 80 cm, the transfer efficiency of power is greater than 85%. The loss of 15% is balanced by a suitable calibration of the internal power meter.

Handpieces

The CO₂ laser radiation is delivered to the treatment area through the handpieces or the scanning units.

A wide range of handpieces can be provided with the SmartXide² TRIO system, having different spot sizes and high performances in specific application field. The system can be provided with a handpiece body which can house different lens assemblies (1.5", 2", 4", 7" and collimated, please refer to Fig. 9).

Moreover, a 5" handpiece and a 8" handpiece are available: each of them consists of the handpiece body (and lens assembly) with interchangeable handpiece spacers. These spacers are either straight, straight with backstop, 90° and 120° delivery for 5" handpiece; straight and straight with backstop for 8" handpiece (please refer to Fig. 10 and Fig. 11).

NOTE

If the 8" handpiece is connected to the EndoScan unit, the user has not to select scanning figures larger than 60%.

The term "spot size" identifies the diameter of the laser beam (and therefore the diameter of the circular area exposed to laser radiation) when the handpiece is hold perpendicularly to the surface to be treated and the laser beam is in focus.

The spot of the collimated handpiece is about 2.0mm (at 86% of output power).

The handpiece is attached to the distal end of the articulated arm.

An air flow is provided by an internal pump in order to avoid dust and particles deposition on the optics during laser operations.

The inlet connector on the handpiece is connected via a black plastic PVC tube to the proper output connector located on the rear side of the system. See par. 7.5 for details on the connections.

During system operation never disconnect the air tube.



Fig.7 - Laser handpiece

It is also possible to connect the handpiece to an external smoke evacuator via a flexible hose.

In the lower part of the system side panel there is a suitable holder for the connection hose of an external smoke evacuator.

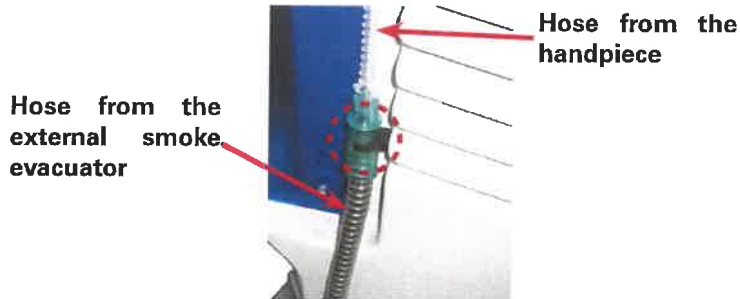

Fig.8 - Positioning of the smoke evacuator hose on the system



CAUTION - Possible risk for patient/operator

"As the aiming beam passes down the same delivery system as the working beam it provides a good method of checking the integrity of the laser delivery system. If the aiming beam is not present at the distal end of the delivery system, its intensity is reduced, or it looks diffused, this is a possible indication of a damaged or not properly working system" (IEC 60601-2-22).

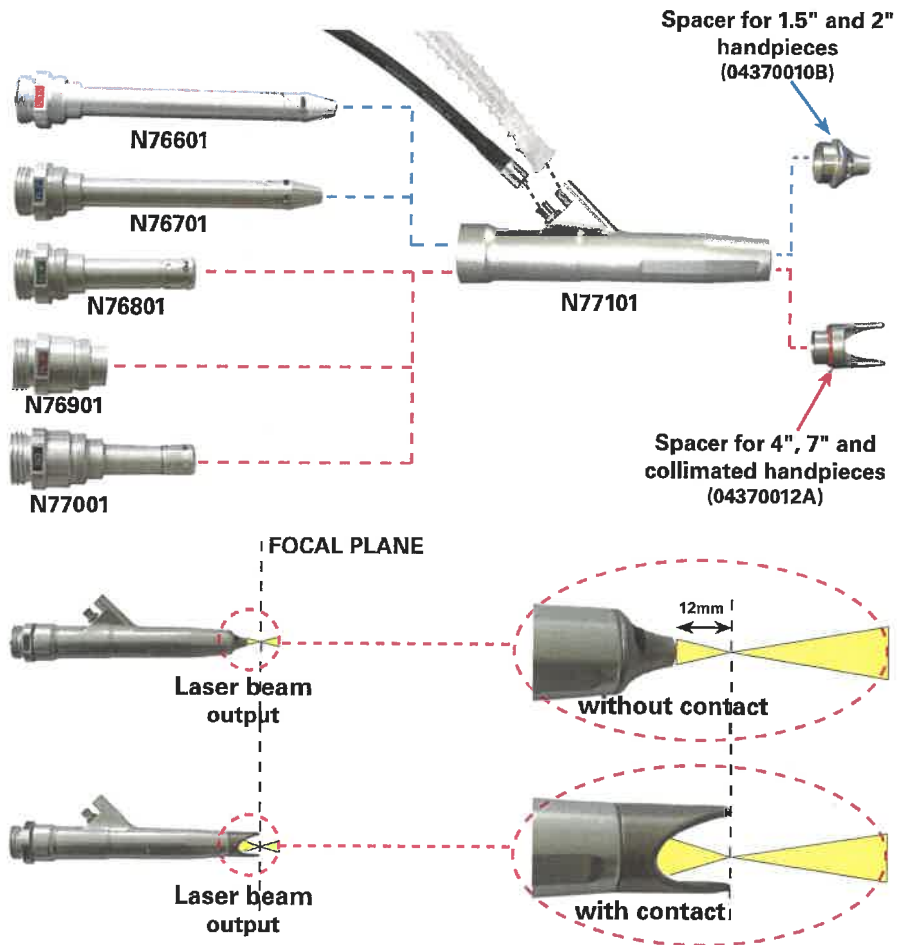

Fig.9 - Assembling the handpieces

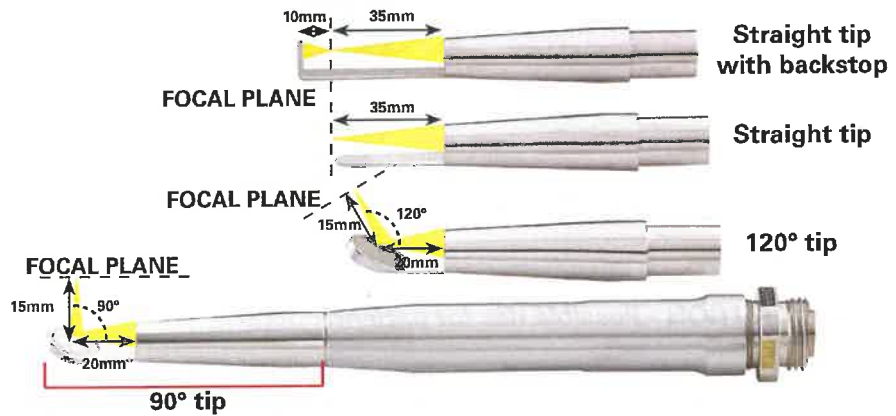

Fig.10 - 5" handpiece and spacers

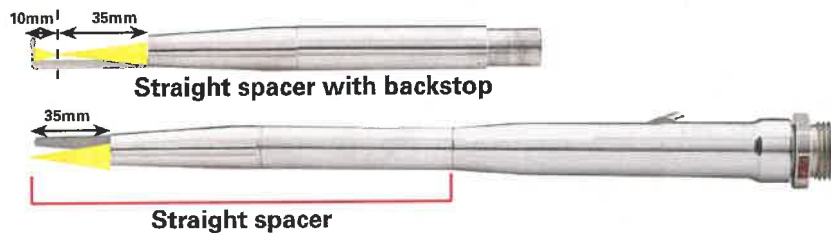

Fig.11 - 8" handpiece and spacers

Changing lens assembly

To change the lens assembly, disconnect the air pipes from the handpiece barrel, then unscrew the handpiece from the articulated arm.

Extract the lens assembly currently screwed onto the handpiece and screw the one to be used.

Connect again the air purge tubing and the smoke evacuator (if present).



CAUTION - Possible risk for patient/operator

Please pay attention to insert the lens assembly you want really to use: the focal length is marked on the holder itself!

Changing handpiece spacer

The handpiece spacer can be easily changed by removing the final part of the handpiece itself and inserting the new spacer.

Use the narrow spacer for 1.5" and 2" handpieces, the open one for 4", 7" and collimated handpieces (please refer to Fig. 9).

Use their own spacers for 5" and 8" handpieces.

CO₂ handpieces for dental applications

The handpiece shown in Fig.12 can be provided for the CO₂ laser source to be used for dental applications for the treatment of soft tissues.

The handpieces consist of the handpiece body and two interchangeable handpiece apertures: a straight aperture that transmits the laser beam in line with handpiece's axis and an aperture with mirror to deflect the laser of 120°.



Fig.12 - 2" CO₂ dental handpiece

Changing handpieces

To change handpieces, disconnect the air purge tubing from the handpiece body. Unscrew the handpiece from the articulated arm, screw on the new handpiece and connect the air purge tubing.

Changing handpiece aperture

The handpiece aperture is easily changed by unscrewing the final part of the handpiece itself and screwing the new aperture.

Changing contact tips

Pull on the tip to remove and push the new tip into the hole located at the end of the aperture until it stops.

6.3.2. Hollow waveguide (CO₂ fiber)

The CO₂ laser beam can be delivered also through a hollow waveguide to allow easier delivery of laser energy to the targeted tissue.

The waveguide is manufactured by Laser Engineering and has been cleared by FDA with K112166. It is supplied in 2m length and can be used also with various handpieces having different lengths and shapes manufactured by TTI Medical and cleared by FDA with K952006.

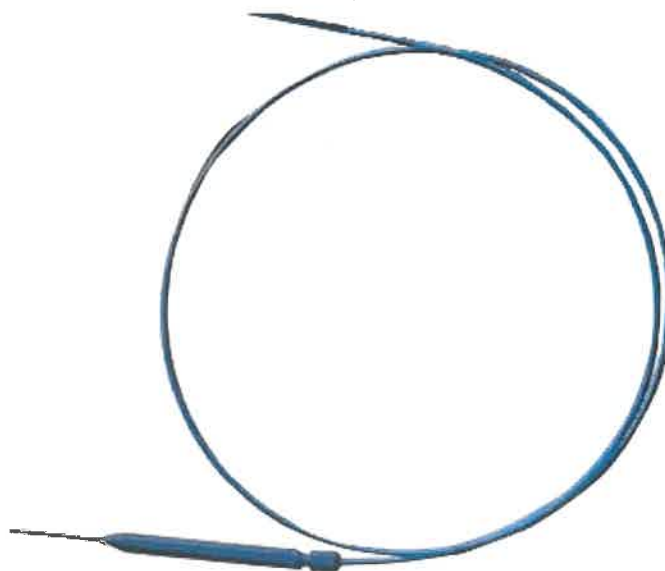
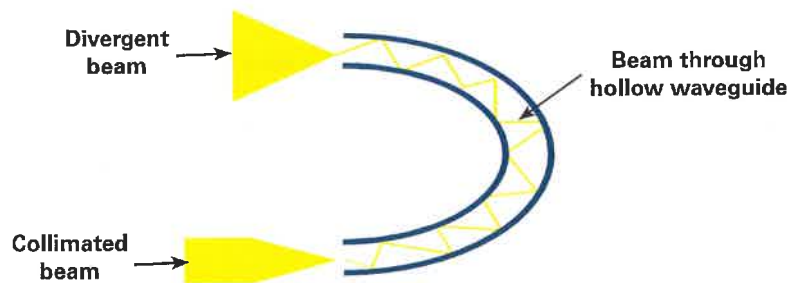

Fig.13 - Hollow waveguide and handpiece

**NOTE**

- When operating with the fiber, always ensure that purge air is flowing through the fiber port and fiber prior to laser beam emission (please refer to par. 7.4).
- Please refer to the proper fiber's instruction guide for complete description, maintenance procedures and technical specifications.

ATTENTION!

- The fiber is designed to be used in a non-contact mode. Keep inadvertent contact with the tissue and fiber tip to a minimum.
- Always use the minimum laser power setting for a given procedure. Minimize the amount of bending of the fiber to avoid damage to the fiber or handpiece.
- Fiber damage can occur when using a laser at a high power level or at an extreme bending radius for long lasing time periods.

6.4. Diode laser delivery system and handpieces

The diode laser beam is delivered through an optical fiber.

The optical fiber is guided to the target tissue with the aid of the handpiece.

The spot size is effectively the diameter of the fiber currently connected to the system.

Use only optical fibers provided by DEKA.

Carefully read the instructions provided with the optical fiber.

Refer to Fig. 14 for an overview of the fiber, the handpiece and two (100mm and 150mm long) of the cannulas which can be provided with the system.



Fig.14 - Diode laser handpiece with cannulas and fiber



CAUTION - Possible risk for patient/operator

As the aiming beam passes down the same delivery system as the infrared working beam it provides a good method of checking the integrity of the laser delivery system. If the aiming beam is not present at the distal end of the delivery system, its intensity is reduced, or it looks diffused, this is a possible indication of a damaged or not properly working system (IEC 60601-2-22).

In this case, do not use the system until the fiber optic is replaced.

6.4.1. Diode handpieces for dental applications

The handpiece shown in the following picture can be provided with the diode laser source to be used for dental applications.



Fig.15 - Diode dental handpiece

Proceed as follows to use this handpiece:

1. Strip the fiber as described in par. 12.1.5. in order to have at least 5cm of bare fiber.
2. Insert the fiber into the handpiece by unscrewing the threaded cap highlighted in Fig. 15 and pushing the fiber until it exits from the other end for about 6 cm.

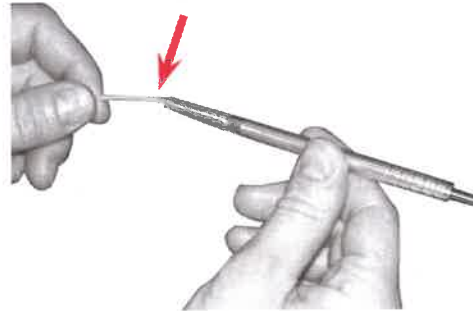

Fig.16 - Inserting the fiber optic into the handpiece

3. Insert the bare fiber into the tip which is to be used and push until it exits from the other end for about 2-3mm.
4. Tighten the tip onto the handpiece.
5. Screw again the ring nut highlighted in Fig. 15.



Fig.17 - Connecting the tip

NOTE

To disassemble the handpiece, reverse the steps.

7. INSTALLATION

Remove the device from its packaging, position it on a horizontal surface and lock the front wheels by using the locking system provided on them, so that it is stable.

Conserve the packaging in case it is necessary to repack the device for future transport or storage. Check that the items listed in Section "Accessories" are included inside the box together with the device.

ATTENTION - Possible equipment damage

Located inside the accessories case, there is a temperature recorder. Upon receipt of shipment inspect the temperature indicator. If it is red (see picture below), before installing and using the device, contact the Technical Assistance Service.



7.1. System requirements

7.1.1. Dimensions and weight

The SmartXide²TRIO system has the following dimensions and weight:

Table 4 - Dimensions and weight

| | |
|---------------|--|
| Height | 234 cm 167 cm (with folded articulated arm) |
| Width | 59 cm |
| Depth | 56 cm |
| Weight | 100kg |

7.1.2. Electrical requirements

Please consider the following electrical requirements before installing the system:

- make sure the socket is efficiently earthed.
- the SmartXide² TRIO system unit should not share a power line with other heavy power-load equipment. The system should be on a separate power line with a separate circuit breaker.
- The SmartXide²TRIO should not be used near other equipment.
If this is necessary, observe the SmartXide² TRIO to verify normal operation in the stacked configuration in which it will be used.

7.1.3. Environmental requirements

Follow these environmental requirements to properly maintain the system:

- Keep the air free of corrosive substances, such as salts and acids. These pollutants may damage electrical wirings;
- Keep dust particles to a minimum. Dust particles can cause damage to the system;
- Do not place system near heat sources.
- Observe the following temperature, humidity and pressure requirements:

Table 5 - Operating and environmental conditions

| | |
|-----------------------|----------------------------|
| Operating temperature | From 15°C to 35°C |
| Operating humidity | From 20% to 80% |
| Atmospheric pressure | From 70,000Pa to 106,000Pa |

Table 6 - Transport and storage conditions

| | |
|------------------------------|----------------------------|
| Storage temperature | From 5°C to 50°C |
| Temperature during transport | From 5°C to 50°C |
| Operating humidity | From 10% to 90% |
| Atmospheric pressure | From 70,000Pa to 106,000Pa |

7.1.4. System specifications

The SmartXide²TRIO system is equipped with a CO₂ laser source, emitting an infrared beam, and an aiming laser source, emitting a visible red beam.

These two laser sources have the emission specifications listed in Table 7 and Table 8:

Table 7 - System specifications

| Type | Value |
|------------------------------|---|
| Mains voltage | 100-120V~ 50/60Hz 220-230V~ 50Hz |
| Absorbed electric power | 1600 VA (max) |
| Circuit breaker | 16A delayed |
| Electrical protection degree |  |
| Electrical protection type | I |
| Laser class | 4 |
| Use/Pause | Intermittent: use 1min, pause 3min |

Table 8 - CO₂ laser source emission features

| Type | Value |
|----------------------------|--|
| Wavelength | 10.6µm |
| Maximum output laser power | 60W |
| Method of Optical Output | 7-mirror articulated arm, hollow waveguide |

| | | |
|---|---|----------|
| Divergence of laser beam (full angle d_{63}) (i.e., at 63% of output power) Articulated arm handpiece's output | 1.5" handpiece | 70 mrad |
| | 2" handpiece | 52 mrad |
| | 4" handpiece | 26 mrad |
| | 5" handpiece | 20 mrad |
| | 7" handpiece | 12 mrad |
| | 8" handpiece | 11 mrad |
| | Collimated handpiece | 3.2 mrad |
| Diameter of laser beam d_{63} (i.e., at 63% of output power) Articulated arm handpiece's output | 1.5" handpiece | 0.125 mm |
| | 2" handpiece | 0.155 mm |
| | 4" handpiece | 0.267 mm |
| | 5" handpiece | 0.325 mm |
| | 7" handpiece | 0.489 mm |
| | 8" handpiece | 0.530 mm |
| | Collimated handpiece | 1.5 mm |
| Hollow waveguide inner diameter | 500 μ m | |
| Hollow waveguide outer diameter | 850 μ m | |
| Hollow waveguide length | 2m | |
| Divergence at waveguide's output | 56 \pm 10 mrad | |
| Hollow waveguide maximum power | 40W | |
| Power stability on 1 hour | \leq 20% | |
| Maximum Permissible Exposure (MPE) | 1 kW/m ² @ 10600nm | |
| Nominal Ocular Hazard Distance (NOHD) | 29m 100m (with collimated handpiece) | |
| Emission | Controlled by footswitch | |

Table 9 - Specifications for the aiming source of CO₂ laser

| Type | Value |
|---|----------|
| Wavelength | 635nm |
| Maximum power (source output) | 4mW |
| Output mode | Circular |
| Divergence (source output) | 0.6mrad |
| Diameter (source output) | 1.8mm |
| Laser class (source output) | 3R |
| Relative position with CO ₂ source | Coaxial |

Table 10 - Operating characteristics

| Type | Value |
|-----------------|---|
| Aiming Beam | Visible. Intensity selectable between 1% and 100%; step: 2% between 2% and 10%, step: 10% between 10% and 100%. |
| Operating modes | <ul style="list-style-type: none"> • CW mode: the average output power can be selected from 0.5W to 60W. • UP mode: the average output power can be selected from 0.5W to maximum power. • SP mode: the average output power can be selected from 0.1W to 15W; the frequency from 5Hz to 100Hz. • DP mode: the average output power can be selected from 0.2W to 15W; the frequency from 5Hz to 100Hz. The selectable frequencies depend on the selected power value, as shown in Table 15. • HP mode: the average output power can be selected from 0.1W to 8W; the frequency from 5Hz to 100Hz. |
| Exposure modes | Continuous exposure mode or timed exposure mode. The timed exposure mode allows both single exposure or repeated exposures. When timed exposure mode is selected, the exposure time can be selected between 0.01s and 0.9s. When the repeated exposures mode is selected the "T.OFF" time can be modified from 0.1s to 5s. |

7.1.5. Diode laser source (optional)

The SmartXide² TRIO system can be equipped with two different versions of diode laser source emitting an infrared beam (IR) with an auxiliary aiming laser source emitting a visible red beam. These two laser sources have the following emission specifications:

Table 11 - Diode laser source features

| Type | Value |
|---------------------------------------|--|
| Wavelength | 940nm±10nm or 980nm±10nm |
| Maximum output power | 50W |
| Output mode | Multimode circular |
| Maximum Permissible Exposure (MPE) | 30.20 W/m ² @940nm 36.31 W/m ² @980nm |
| Nominal Ocular Hazard Distance (NOHD) | 6.6m @940nm 6.0m @980nm |
| Beam divergence at the fiber output | 200mrad |

Table 12 - Specifications for the aiming source of diode laser

| Type | Value |
|-------------------------------|-------|
| Wavelength | 635nm |
| Maximum power (source output) | 3mW |
| Laser class (source output) | 3R |

Table 13 - Diode fiber characteristics

| Type | Value |
|---------------------|-------------------------|
| Connector | SMA 905 |
| Fiber length | 3m |
| Fiber core diameter | 200µm 300µm 600µm |

Table 14 - Diode source operating characteristics

| Type | Value |
|------------------------|--|
| Aiming Beam | Visible. It can be switched CW and PW. |
| Power indication | Digital: value displayed on the screen of the control panel. |
| Power | The power level can be selected from 0.5W to maximum power. |
| Operating modes | CW and PW . |
| Exposure modes | Continuous, single pulse, burst or repeated burst. |
| On period (TON) | This value can be selected, if in PW mode, between 5ms and 2000ms. |
| Off period (TOFF) | This value can be selected, if in PW mode, between 5ms and 2000ms. |
| Exposure time | This value can be selected, if in CW mode, between 5ms and 2000ms. |
| Number of burst pulses | It can be set, in PW mode, between 2 and 50. |
| Delay between bursts | It can be set, in PW mode, between 0.5s and 5s. |
| Emission | Controlled by footswitch. |

7.2. Accuracy of values

The accuracy of all the values mentioned in this manual is reported in the outcome of the project for the SmartXide²TRIO system.

7.3. Installation

Proceed as follows:

- Insert the key into the key switch located on the front side: the key can be inserted only in the “O” position, so the system is still switched off. Do not turn the key to the “I” position.
- Make sure the emergency switch is pulled upwards and the mains breaker is in the “I” position.
- Connect the external interlock network to the socket marked “INTERLOCK”; if there is no external interlock chain, connect the interlock connector supplied with the accessories (see also par. 7.7 in this section).
- Connect the footswitch to the socket marked “FOOTSWITCH”.

ATTENTION - Possible equipment damage

The contacts of the interlock and footswitch sockets must never be connected to the mains otherwise the system should be seriously damaged. Connect these sockets only as specified in this paragraph.

- Connect the mains cable provided with the system to the proper socket located on the rear side of the system.
- Connect the other side of the mains cable to a wall outlet.

ATTENTION - Possible equipment damage

- Make sure that the mains plug is always reachable.
- Make sure the wall outlet is properly grounded.
- Make sure that the mains specifications are met.

7.3.1. Installation of the articulated arm’s counterweight

At system first installation, the counterweight of the articulated arm must be installed. Proceed as follows (please refer to Fig. 18):

- first, if not present, install the support rod of the counterweight following the steps illustrated below:



ATTENTION - Possible equipment damage

When installing the support rod, pay attention to put the two central holes on it (**A** in step 1) onto the proper pins of the articulated arm (highlighted by the dotted line in step 1).

- assemble the heaviest component, **paying attention to put this first component on the opposite side of the articulated arm** (as shown in Fig. 18, step 1) and to insert the special washer of the articulated arm into the groove of the counterweight.



CAUTION - Possible risk for patient/operator

Be very careful while handling the counterweight because it is very heavy: in case of fall, it can damage the equipment or hurt someone!

- install the second component which allows to fix the counterweight: insert the special washer of the articulated arm into its groove and screw it using the provided 5mm Allen wrench.

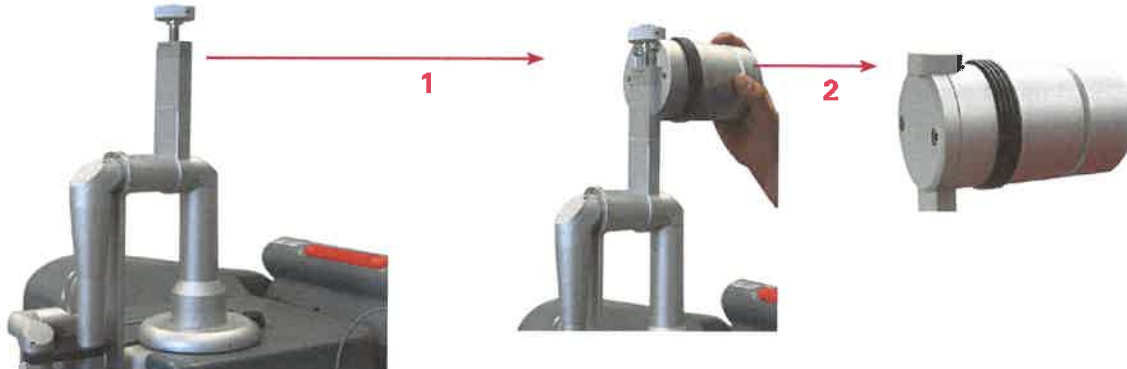

Fig.18 - Installation of the articulated arm's counterweight

ATTENTION - Possible equipment damage

The counterweight and its support rod have always to be removed for long distance transport. To remove them, put the articulated arm in its resting position and reverse the steps in this paragraph.

To move the articulated arm to the working position, remove it from its resting position and act on the adjusting knob in order to balance the counterweight according to the accessory connected to the articulated arm. Turn the knob up to reach a position around the mark "HiScan" if a scanner is connected (without micromanipulator), around the mark "Freehand" if a handpiece is connected.

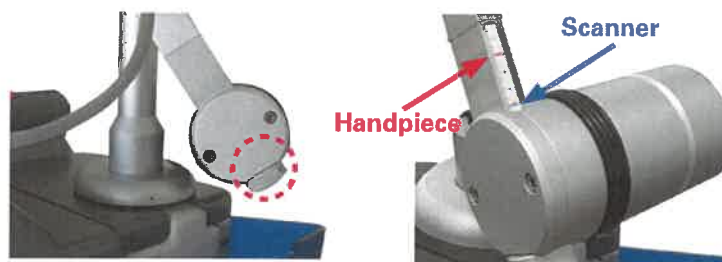

Fig.19 - Counterweight

To place again the articulated arm in its resting position, rotate it slightly outwards and fold it so as to leave the counterweight upward. Secure the arm using the provided clamp on the system.

ATTENTION - Possible equipment damage

Avoid to apply any force to the support cantilever of the articulated arm. Do not hold the arm as shown in the picture below.



7.4. Hollow waveguide connection

To connect the hollow waveguide to the system, first install the fiber pole, insert the fiber connector into the socket on the upper side of the system (Fig.20) and secure the connector nut avoiding to force it; make the fiber pass through the pole.

Let the fiber pass through the passing hole of the other fiber pole shown in Fig. 22.



Fig.20 - Hollow waveguide connection

NOTE

- Before operating ensure that air flow is present at fiber's output: enter the User menu, select the fiber delivery system, put the air flow "continuous", press READY (please refer to par. 8.3.2) and verify that the flow is present and no alarm appears on display.
- Ensure that the waveguide is properly connected to the ST connector on the system and that the connector itself is not loose.
- Ensure that the antibacterial filter is clean (please refer to par. 12.1.7).



CAUTION - Possible risk for patient/operator

- Use only fiber optic authorized by the Manufacturer: please refer to Section "13. ACCESSORIES".
- Always switch off the CO₂ laser source before removing the fiber.
- **The fiber optic is fragile. Never bend it or wind it in close circles.**
- **Always remove the fiber before transporting the system.**
- Be always sure the fiber optic can be moved freely during treatment without getting entangled.
- The surface of the fiber optic connector must never touch, or be touched by objects which could damage it: any damage to this surface may decrease the transmission rate and therefore lead to poor performances.
- **When the fiber is disconnected from the system, always put the proper cap on the ST connector side to protect it and to prevent the entry of dust inside.**
- Either during treatment or when the system is turned off, do not lay the fiber on the floor or anywhere it may be bent or trampled on.
- **Always use the provided fiber pole and holder to hang the fiber optic (see Fig.20).**

7.5. Fiber connection for diode source

Placing the fiber in the handpiece

Proceed with the following steps observing **sterile practices**.

- Attach and lock the cannula to the handpiece.
- Strip the fiber as described in par. 12.1.5: the length of the bare fiber should be at least equal to the length of the cannula to be used plus 7cm.
- Pass the fiber through the tapered proximal end of the handpiece (highlighted in Fig. 21) after unscrewing it three to four turns.
- Advance or retract the fiber so that it extends beyond the end of the cannula no further than 2-3mm.

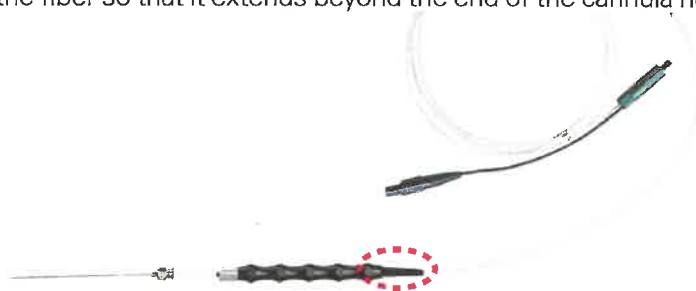

Fig.21 - Fiber, handpiece and cannula

- Tighten the tapered proximal end to secure the fiber to the handpiece.



CAUTION - Possible risk for patient/operator

- **The handpiece and cannula must be cleaned and sterilized prior to use.**
- **Failure to secure the fiber in place may lead to fiber slippage causing patient injury.**

Connecting the fiber to the system

- Remove the black cap - highlighted in Fig. 22, left part - which prevents the fiber from being damaged (*do not touch the fiber input with anything!*);
- Insert the SMA connector of the fiber (1) in the connector (A) of the front panel and secure the connector nut avoiding to force it.
- Insert the connector (2) in the socket (B). A built-in circuit allows to detect the presence of the fiber optic and its correct insertion: the laser source is switched off if the fiber is not properly connected (see Section "Troubleshooting").
- Let the fiber pass through the passing hole of the fiber pole as shown in Fig. 22.

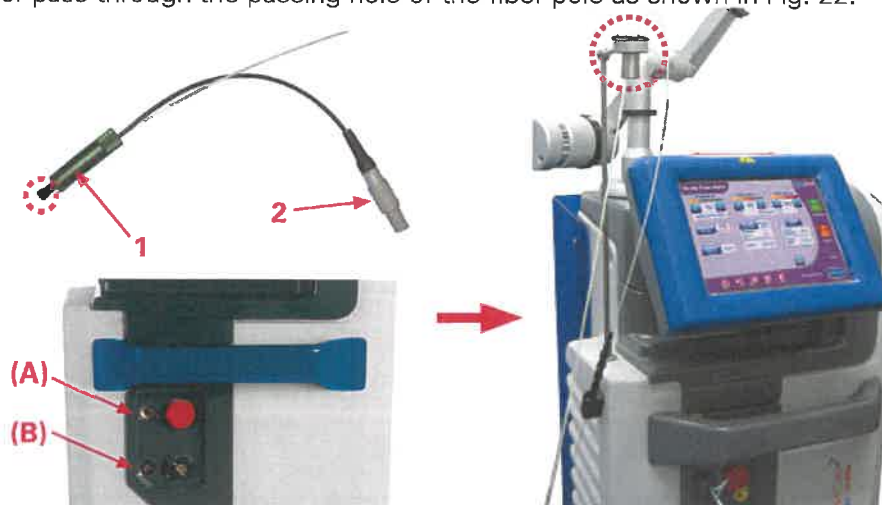

Fig.22 - Connecting the fiber to the system



CAUTION - Possible risk for patient/operator

- **Always use sterile fiber optics, disposable (single use) or re-sterilizable type fibers.**
- Use only fiber optic provided by DEKA M.E.L.A. s.r.l.
- Always switch off the diode laser source before removing the fiber.
- **The fiber optic is fragile. Never bend it or wind it in close circles.**
- Be always sure the fiber optic can be moved freely during treatment without getting entangled.
- The surface of the fiber optic connector must never touch, or be touched by objects which could damage it: any damage to this surface may decrease the transmission rate and therefore lead to poor performances.
- If the fiber is disconnected from the system, always put again the black cap on the SMA connector side to protect it.
- Either during treatment or when the system is turned off, do not lay the fiber on the floor or anywhere it may be bent or trampled on.
- **Always use the provided fiber pole to hang the fiber optic (see Fig.22).**

7.6. User ID chip

The SmartXide² TRIO system is provided with a "User ID" chip which allows the user to enter the "personal" database of user-defined treatments: see par. 8.5 for details.

Pull down the protection panel on the rear side of the system and insert the chip in its housing pushing it and paying attention to put its metallic face in the narrow side of the socket (highlighted in Figure, right side).

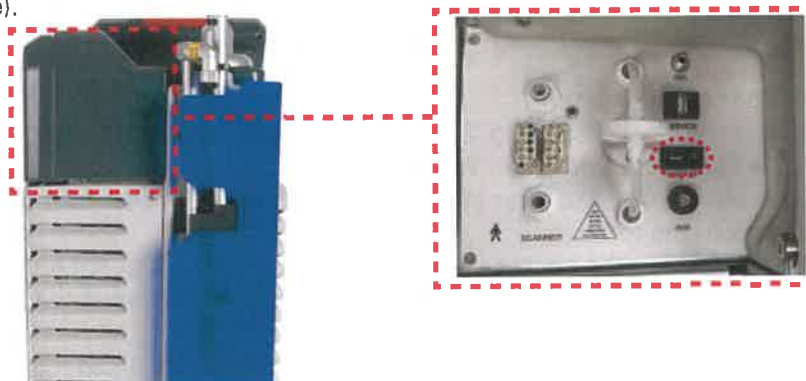

Fig.23 - "User ID" key socket

If the inserted "User ID" chip is recognized by the system, the icon highlighted in Fig. 24 is displayed in the User menu.



Fig.24 - "User ID" icon in the User menu

7.7. Air flow connections

The SmartXide²TRIO system is equipped with an internal pump which produces a filtered internal air flow which prevents dust and particles from depositing on the optics during laser operations. Pull down the protection panel on the rear side of the SmartXide²TRIO system (Fig. 25) to access the air flow outlet connector (highlighted in Figure below): an internal connection links the air pump to this connector.

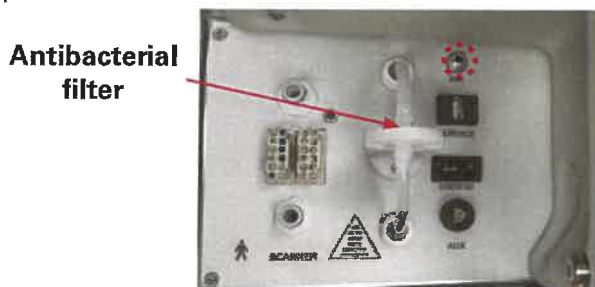

Fig.25 - Air flow connector on system

A black tube is provided to connect this outlet connector to the inlet connector located on the handpiece (see Fig.7).

NOTE

Always verify that the air tube is properly connected to both connectors.

An antibacterial filter is present on the air flow path both towards the articulated arm and the CO₂ fiber: always ensure that the antibacterial filter is clean (please refer to par. 12.1.7).

ATTENTION!

When operating with the fiber, always ensure that purge air is flowing through the fiber port and fiber prior to laser beam emission (please refer to par. 7.4).

As an option, the system can also be connected to an external air flow source: the connector available on the rear side of the SmartXide² TRIO system (see Fig.26) is for medical-grade compressed air. The user can select the source of the air flow ("internal" or "external") from the CO₂ fiber user menu: please refer to par. 8.3.2 for details.



Fig.26 - External air flow connector on system

NOTE

Use the proper plastic holders placed on the articulated arm to position the air tube and, if present, the hose for the smoke evacuator; use the larger housing for the scanning unit cable. See the Figure aside.



7.8. Articulated arm working position

In order to move the articulated arm to its working position proceed as follows:

- move upwards the lock that blocks the articulated arm (see the enlarged detail in the Figure below);
- move the articulated arm away from its resting position rotating it as shown in the figures below.

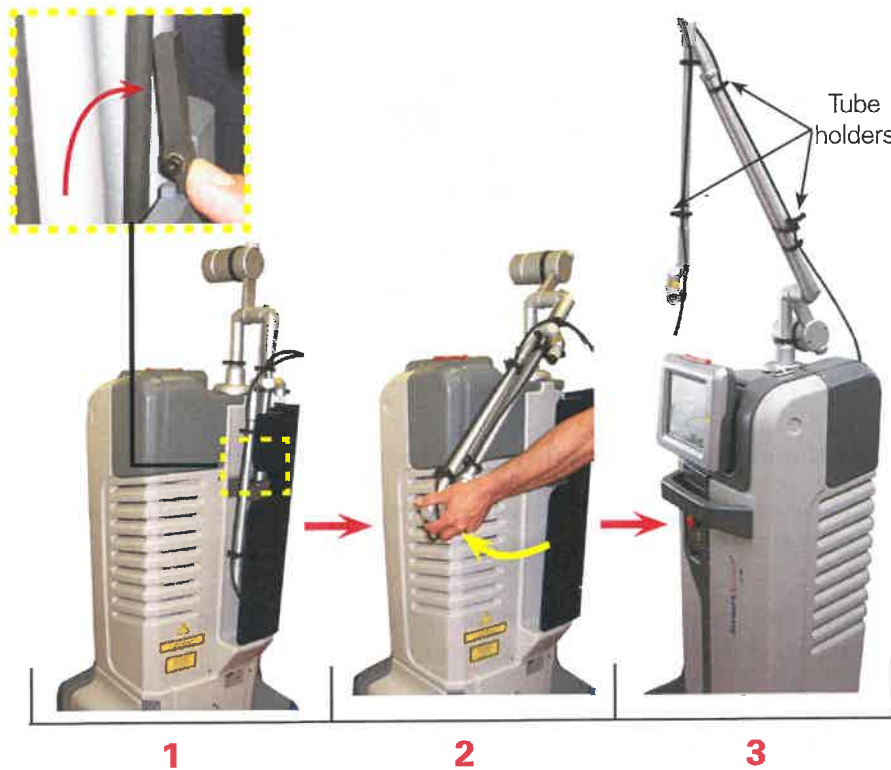

Fig.27 - Articulated arm working position

NOTE

If the articulated arm has been properly taken out from its resting position, the tube holders on the articulated arm are placed externally as highlighted in Fig. 27. *The position shown below is not correct.*



Fig.28 - Proper resting position of the arm

NOTE

To return the arm to its proper resting position, please take care that the two arrows shown in the following figure are aligned.

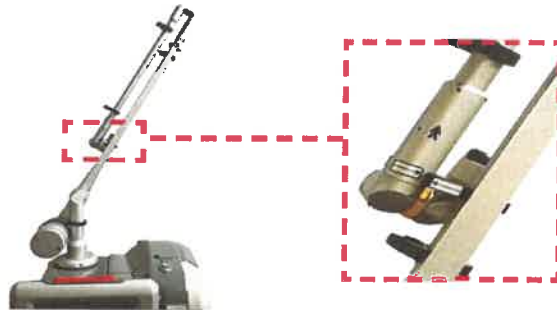

7.9. Remote Interlock

The interlock socket can be used as an additional precautionary measure to stop emissions in case a specific external event occurs.

For instance, all the doors leading to the system operating area can be provided with series-connected microswitches (normally closed). In this case the opening of any of these doors results in an "INTERLOCK" alarm message (see the Section "Faults and troubleshooting") so the emission is immediately stopped.

To connect an external interlock chain, the interlock connector supplied with the accessories can be used.

Open the connector as shown in the following figures. Note that there is a jumper between contacts 1 and 2 (set by factory).

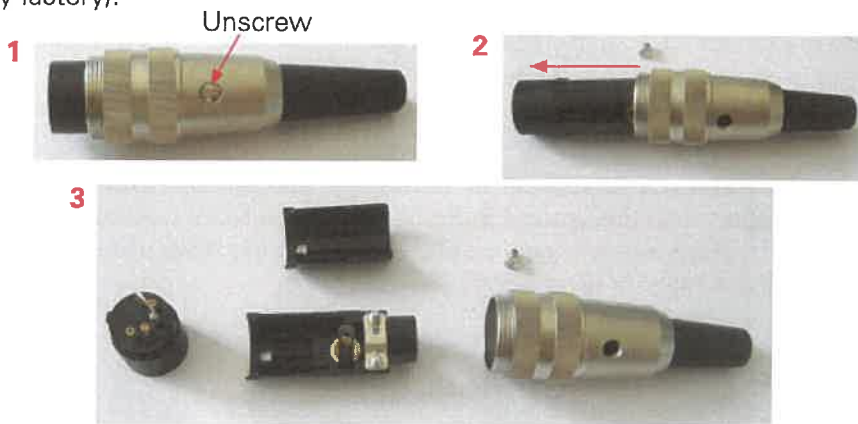

Fig.29 - How to open the interlock connector

To use an external interlock chain, proceed as follows:

- remove the jumper between the contacts 1 and 2;
- connect these contacts to the external network. Note that the interlocks must be normally closed in order to let the system operate otherwise an INTERLOCK fault is stated and the system is stopped.



No voltage level should be applied to the contacts of the interlock connector.

If no external interlock network is set up, the interlock connector provided with the system (accessories) must be connected to the interlock socket in order to disable interlock fault detection.

7.10. Moving/transporting the device

The device is susceptible to misalignment if not handled properly. It should never be banged, jolted, dropped, turned upside down, tilted or knocked.

Before moving/transporting the system, disconnect all accessories (handpieces, mains cable, footswitch, and interlock connector), **fold the articulated arm**, and pack the accessories in their appropriate cases.

7.10.1. Moving the device

To move and guide the system, unblock the rotating wheels and use the handle located on the front of the system, making sure to move the system at a slow pace. Do not use the rear cord wrap to transport the system.

Inclines

When moving the system up or down inclines, always travel in line with the slope. The system should never be moved diagonally or directly across an incline. Doing so may result in loss of control of the system and damage to the system or injury may result.

Thresholds

When moving the system over a threshold, and if necessary due to the height of the threshold, firmly grasp the front handle and pull the system forward until the front wheels cross the threshold. Depending on the height of the threshold, a slight lift using the front handle may be necessary to get the front wheels started over the threshold. Continue pulling the system forward slowly until the rear wheels cross the threshold. Rapidly moving the system across a threshold can result in system instability resulting in damage to the laser system and/or possible injury.

7.10.2. Transporting the device

When transporting the system by vehicle, store it in its own packaging, if possible, or secure it with a strap or structural support with the wheels locked inside the vehicle, making sure not to bump or press the articulated arm. The system should be protected from the strap using padding or blankets. Do not transport the device tilted or lying down.

8. USE OF THE SYSTEM

8.1. Starting up the system

Insert the key into the key selector and turn to the "1" position. The system enters a self-test phase during which the introductory screen "System check" is displayed.

ATTENTION

During the self-test phase, the SYSTEM READY indicator on the top cover of the system and the LED on the control panel flash. This allows to verify its correct working. It is recommended to verify that the lamp is flashing during this phase. Otherwise call the Technical Assistance Service.

Once the internal check is over, if any problem is detected the system displays a "SYSTEM FAULT" menu: refer to the "Troubleshooting and solutions" section for possible solutions to the problem; otherwise an introductory warning is displayed.



CAUTION- Possible risk for patient/operator

The operator and all personnel in the operating area are always required to wear protective eyewear when operating. Never look directly into the handpiece or into apertures labelled "LASER APERTURE", even while wearing protective eyewear.

Once the "OK" key has been pressed, the system displays the Home menu:



Fig.30 - Home menu





The two keys on the left allow the selection of the source type to be used: these keys make the operator enter the so called "User" mode as the operator himself has to select the emission characteristics (pulse number, pulse length, fluence) on his own experience.



Data can also be saved for future uses.

Keys are shown with lighter colours if the related handpiece/fiber is not connected or it is not valid.

The keys on the right allow to select the application and enter the related user-defined database.

The options described below are common to all system menus:

| | |
|---|--|
|  | This key goes to the Favorite menu |
|  | This key goes to the Home menu |
|  | This key goes to the previous displayed screen |
|  | This key enters the database mode |

| | |
|---|----------------------------------|
|  | This key enters the Set-up menu |
|  | This key displays an info screen |

Keys are shown with lighter colours if the related option is temporarily disabled.

The system automatically selects the following status:

- "STAND BY" mode;
- Footswitch disabled.
- Aiming, exposure, emission and scanning parameters: last used values for that delivery system.

8.2. Management of the selected source

'STAND BY'/'ON' key

The 'STAND BY'/'ON' key allows to switch off/on the selected source.

If it is green light coloured, it means that the key is disabled;

if it is green bright coloured, it means that the key is enabled to switch on the source;

if it is orange coloured, it means that the selected source is ON and it can be switched off by pressing the key itself.

'READY' key

The 'READY' key allows to enable footswitch in order to avoid unwanted emissions which might occur if it is accidentally pressed when the source is switched on.

The operator is suggested to use the READY option to disable footswitch while selecting the parameters as a precautionary measure.

Emission is enabled if both the READY key and the SYSTEM READY indicator on the system upper cover are permanently lit.

'EMISSION' LED

The "EMISSION" LED is under the "READY" key and, when lit, indicates that emission is in progress.

8.3. User mode for CO₂ source

The "User" mode allows to fully control emission parameters by "manually" selecting the emission mode, the pulse configuration and the power and/or frequency levels. As the CO₂ area is pressed, a selection screen is displayed which allows to select the delivery system between articulated arm and hollow waveguide ("FIBER").



Fig.31 - CO₂ Free Hand mode

If the "Articulated arm" option is selected, the user can choose between handpiece ("Free hand" mode) or scanning system.

The key related to the scanning unit currently connected to the system is highlighted on the selection screen.

For the description of all the available scanning units, please refer to the relevant Section of this Operator's Manual (Section "Scanning units" on page 61).

8.3.1. CO₂ Free Hand mode



Fig.32 - CO₂ Free Hand mode

Power

The POWER selection keys increase or decrease and display power level. The range of available values changes according to the selected emission mode: please refer to the description of the exposure modes in this paragraph.

See also par. 8.7.

Frequency

The FREQUENCY area displays frequency of laser emission; the FREQUENCY selection keys increase or decrease it from 5Hz to 100Hz. *These keys appear only when the SP or DP emission mode has been selected.*

See also par. 8.7.

Emission mode

The area "EMISSION MODE" alternately selects and displays "CW", "SP", "UP", "DP" or "HP" emission mode.

In **CW mode**, laser emission is continuous: the CO₂ laser source is enabled to emission as long as it is switched on, so it provides a constant output power level whose value has to be selected by the operator according to the treatment to be performed.

The POWER selection keys allow to change the power value from 0.5W to 60W.

In **SP mode** the CO₂ laser source is pulsed.

The operator can select the frequency - that is how many times per second the source is switched on and off - and the power value.

The FREQUENCY selection keys allow to change the frequency value between 5Hz and 100Hz; the POWER selection keys allow to change the power value between 0.1W and 15W.

In **DP mode** the CO₂ laser source is pulsed.

The operator can select the frequency - that is how many times per second the source is switched on and off - and the power value.

According to the selected power value, the allowed frequency range changes as shown in the Table below.

Table 15 - Power and Frequency selection in DP mode

| Power | Available values for the "Frequency" parameter |
|-----------------|--|
| 0.2W | 5Hz |
| 0.2W < P < 0.5W | up to 10Hz |
| 0.5W ≤ P < 3W | up to 20Hz |
| 3W ≤ P < 4W | up to 50Hz |
| 4W ≤ P < 5W | up to 80Hz |
| 5W ≤ P ≤ 15W | up to 100Hz |

In **UP mode** the CO₂ laser source is pulsed.

The system sets an optimal frequency while the output power level has to be selected by the operator according to the treatment to be performed.

The POWER selection keys allow to change the power value from 0.5W to 60W.

In **HP mode** the CO₂ laser source is pulsed.

The operator can select the frequency - that is how many times per second the source is switched on and off - and the power value.

The FREQUENCY selection keys allow to change the frequency value between 5Hz and 100Hz; the POWER selection keys allow to change the power value from 0.1W to 8W.

Exposure

The system allows to control the exposure time during a laser treatment acting on the CO₂ shutter. The selected exposure mode is displayed on the screen in the "Exposure mode" area. Touch this area to change the exposure mode.

Three exposure modes can be selected:

- continuous - "Contin." on the screen -;
- timed single exposure - "Single" on the screen -;
- timed repeated exposures - "Repeat." on the screen -.

Note that the emission mode - CW/SP/UP/DP/HP - can be changed regardless of the selected exposure mode.

In **continuous exposure mode**, the exposure time is fully controlled by the operator acting on footswitch: as long as footswitch is kept pressed, the shutter is open and therefore laser emission occurs.

When the **single exposure mode** is enabled and footswitch is pressed, the system opens the shutter and keeps it open only for the selected exposure time. Once the selected exposure time is exhausted, the shutter is automatically closed regardless if footswitch is still pressed.

If the operator wants to perform a new exposure, he has to release and then press again footswitch.

The system allows to select the exposure time between 0.01s and 0.9s acting on the two arrows next to the "T.ON" value. The minimum available "T.ON" value depends on the selected frequency as reported in the following Table.

Table 16 - Minimum available TON according to selected frequency

| Frequency | 5Hz | 10Hz | 20Hz | 50Hz | 80Hz | 100Hz |
|-----------|-------|-------|-------|-------|-------|-------|
| Min. TON | 0.10s | 0.05s | 0.03s | 0.01s | 0.01s | 0.01s |



Fig.33 - Exposure mode selection

When **timed repeated exposures mode** is enabled and footswitch is pressed, the system opens the shutter and keeps it open for the selected exposure time.

Once the selected exposure time is exhausted, the shutter is automatically closed then, if footswitch is still pressed, the system waits for the selected "T.OFF" time. Then the shutter is opened again and a new exposure is performed. This sequence is continuously repeated as long as footswitch is kept pressed.

The system allows to change the exposure time between 0.01s and 0.9s acting on the two arrows next to the "T.ON" value and to change the "T.OFF" time between 0.1s and 5s. The minimum available "T.ON" value depends on the selected frequency as reported in the Table 16.

Total Energy and Total Time

The system displays the energy delivered and the time elapsed since the last resetting.

When the system is turned on, these counters are set to zero, then they increase during treatment. If the "RESET" option is pressed, the "TOTAL ENERGY" and "TOTAL TIME" values are cleared.

Aiming source

The two icons "⚙️" and "⚙️" in the "Aiming" area adjust the intensity of the aiming beam from 1% to 100% (step: 2% between 2% and 10%, step: 10% for the other values).

It is also possible to switch off the aiming beam while lasing by pressing the "Dowl" ("Diode off while lasing") option.

Set the "Dowl" option ON to have a clear view of the operating field and well distinguish the tissue ablation planes while operating.



CAUTION- Possible risk for patient/operator

CO₂ aiming beam intensities higher than 60% require an optical protection as indicated in par. 5.2.1. The system displays a warning icon next to the selected value (if higher than 60%).

Scanning unit

Press the area displaying the type of the scanning unit currently connected to the system in order to activate it.

The screen displays a message warning the operator that the delivery system selection has been changed; moreover the operator is reminded to control the scanning unit connections.

8.3.2. CO₂ Fiber user mode



Fig.34 - CO₂ Fiber user mode

Power

The POWER selection keys increase or decrease and display power level. The range of available values changes according to the selected emission mode and to the air flow mode: please refer to the description of these options in this paragraph.

See also par. 8.7.

ATTENTION - Possible equipment damage

Always use the minimum laser power setting for a given treatment.
Fiber damage can occur when using a laser at a high power level or at an extreme bending radius for long lasing time.

NOTE

The actual output power level from the CO₂ fiber is lower than the selected one, with a typical transmission between 60% and 70%, mainly due to two factors:

- Loss of attenuation in the CO₂ fiber: the laser energy transmitted along the fiber is reduced due to radiation dispersion and absorption inside the fiber itself. The attenuation effect increases when the fiber is bent or wound during use.
- Contamination of the CO₂ fiber: the distal tip of the fiber can partially (or completely) clog up with the residues of burns and/or blood.

Frequency

The FREQUENCY area displays frequency of laser emission; the FREQUENCY selection keys increase or decrease it from 5Hz to 100Hz.

These keys appear only when the SP or DP emission mode has been selected.

See also par. 8.7.

Emission mode

The area "EMISSION MODE" alternately selects and displays "CW", "SP", "UP", "DP" or "HP" emission mode.

In **CW mode**, laser emission is continuous: the CO₂ laser source is enabled to emission as long as it is switched on, so it provides a constant output power level whose value has to be selected by the operator according to the treatment to be performed.

The POWER selection keys allow to change the power value from 0.5W to 60W.

In **SP mode** the CO₂ laser source is pulsed.

The operator can select the frequency - that is how many times per second the source is switched on and off - and the power value.

The FREQUENCY selection keys allow to change the frequency value between 5Hz and 100Hz; the POWER selection keys allow to change the power value between 0.1W and 15W.

In **DP mode** the CO₂ laser source is pulsed.

The operator can select the frequency - that is how many times per second the source is switched on and off - and the power value.

According to the selected power value, the allowed frequency range changes as shown in the Table below.

Table 17 - Power and Frequency selection in DP mode

| Power | Available values for the "Frequency" parameter |
|-------------|--|
| 0.2W | 5Hz |
| 0.2W<P<0.5W | up to 10Hz |
| 0.5W≤P<3W | up to 20Hz |
| 3W≤P<4W | up to 50Hz |
| 4W≤P<5W | up to 80Hz |
| 5W≤P≤15W | up to 100Hz |

In **UP mode** the CO₂ laser source is pulsed.

The system sets an optimal frequency while the output power level has to be selected by the operator according to the treatment to be performed.

The POWER selection keys allow to change the power value from 0.5W to 60W.

In **HP mode** the CO₂ laser source is pulsed.

The operator can select the frequency - that is how many times per second the source is switched on and off - and the power value.

The FREQUENCY selection keys allow to change the frequency value between 5Hz and 100Hz; the POWER selection keys allow to change the power value from 0.1W to 8W.

Exposure

The system allows to control the exposure time during a laser treatment acting on the CO₂ shutter. The selected exposure mode is displayed on the screen in the "Exposure mode" area. Touch this area to change the exposure mode.

Three exposure modes can be selected:

- continuous - "Contin." on the screen -;
- timed single exposure - "Single" on the screen -;
- timed repeated exposures - "Repeat." on the screen -.

Note that the emission mode - CW/SP/UP/DP/HP - can be changed regardless of the selected exposure mode.

In **continuous exposure mode**, the exposure time is fully controlled by the operator acting on footswitch: as long as footswitch is kept pressed, the shutter is open and therefore laser emission occurs.

When the **single exposure mode** is enabled and footswitch is pressed, the system opens the shutter and keeps it open only for the selected exposure time. Once the selected exposure time is exhausted, the shutter is automatically closed regardless if footswitch is still pressed.

If the operator wants to perform a new exposure, he has to release and then press again footswitch. The system allows to select the exposure time between 0.01s and 0.9s acting on the two arrows next to the "T.ON" value. The minimum available "T.ON" value depends on the selected frequency as reported in the following Table.

Table 18 - Minimum available TON according to selected frequency

| Frequency | 5Hz | 10Hz | 20Hz | 50Hz | 80Hz | 100Hz |
|-----------|-------|-------|-------|-------|-------|-------|
| Min. TON | 0.10s | 0.05s | 0.03s | 0.01s | 0.01s | 0.01s |

When **timed repeated exposures mode** is enabled and footswitch is pressed, the system opens the shutter and keeps it open for the selected exposure time.

Once the selected exposure time is exhausted, the shutter is automatically closed then, if footswitch is still pressed, the system waits for the selected "T.OFF" time. Then the shutter is opened again and a new exposure is performed. This sequence is continuously repeated as long as footswitch is kept pressed.

The system allows to change the exposure time between 0.01s and 0.9s acting on the two arrows next to the "T.ON" value and to change the "T.OFF" time between 0.1s and 5s. The minimum available "T.ON" value depends on the selected frequency as reported in the previous Table.

Air flow

Press the "**Air flow**" area in the CO₂ Fiber user menu to choose an air flow mode for the CO₂ fiber.



Fig.35 - "Air flow" menu for CO₂ Fiber

First of all select whether the source of the air flow for the fiber is internal ("**Internal**" option in the menu) or external ("**External**" option in the menu) air.

The system includes a compressor that can supply filtered (through an antibacterial filter) internal air. As an option, an external air supply (e.g. a pressurized tank) can be connected to the system. Please refer to par. 7.7 for details about connections.

Then, it is possible to set the air flow mode to "**Continuous**" (i.e. the air flows continuously when the system is in READY status), "**Timed with emission**" (i.e. the air flows when the CO₂ laser source is operating) or "**OFF**" (no air flow).

NOTE

To avoid damage to the delivery system, if the "**OFF**" option is set, the maximum power value allowed by the system is 10W.

When working with the **internal** air flow, the power selection is limited to 30W.



CAUTION- Possible risk for patient/operator

- Use medical-grade compressed air.
- During intrauterine laser surgery, do not use air to purify the fiber or for insufflation. Otherwise an air embolus could occur.
- During laser function, pressurized purification air comes out from the fiber opening. To reduce the risk of air embolism, do not bring the opening into contact with a blood vessel or vascular tissue.



ATTENTION - Possible equipment damage

- To avoid damage to the CO₂ fiber and to the delivery system, connect an external source of pressurized air if fiber bending radius is less than 45 mm.
- The external air flow must have a pressure between 3 bar and 4 bar.

IMPORTANT!

- Before starting procedure, ensure that the air flow is present at the delivery system output.
- The antibacterial filter must be inspected before each use and must be replaced periodically. The filter life depends on the frequency and conditions of use. If the filter is dirty or if you notice a decrease in the air flow, it must be replaced.

Aiming source

The two icons  and  in the "Aiming" area adjust the intensity of the aiming beam from 1% to 100% (step: 2% between 2% and 10%, step: 10% for the other values).

It is also possible to switch off the aiming beam while lasing by pressing the "Dowl" ("Diode off while lasing") option.

Set the "Dowl" option ON to have a clear view of the operating field and well distinguish the tissue ablation planes while operating.



CAUTION- Possible risk for patient/operator

CO₂ aiming beam intensities higher than 60% require an optical protection as indicated in par. 5.2.1. The system displays a warning icon next to the selected value (if higher than 60%).

Total Energy and Total Time

The system displays the energy delivered and the time elapsed since the last resetting.

When the system is turned on, these counters are set to zero, then they increase during treatment.

If the "RESET" option is pressed, the "TOTAL ENERGY" and "TOTAL TIME" values are cleared.

8.4. User mode for diode source

As the "Diode" area is pressed in the Home menu (if enabled, see Fig. 30), the "Diode Free Hand" screen for the diode source management is displayed.

The system automatically detects the presence and the size of the connected fiber: its diameter is displayed on the screen in the "**FIBER**" area (highlighted by the red square in Fig. 36). Moreover, by pressing this area, the system displays further details on the connected fiber.



CAUTION- Possible risk for patient/operator

The operator is recommended to always check that the fiber's diameter displayed by the system matches the diameter of the connected fiber (marked on the fiber's connector).



Fig.36 - Diode Free Hand mode

Power

The POWER selection keys increase or decrease power from 0.5W to 50W.

NOTE

The maximum available power value depends also on the fiber currently connected to the system.

Emission mode

The "EMISSION MODE" area alternately selects and displays either CW or PW emission mode.

In **CW mode**, laser emission is continuous: the diode laser source is enabled to emission as long as it is switched on, so it provides a constant output power level whose value has to be selected by the operator according to the treatment to be performed.

In **PW mode** the diode laser source is pulsed.

The operator can select the output power level and also the TIME ON (that is the time the source is switched on) and the TIME OFF (that is the time the source is switched off). Moreover, the average output power level and the frequency value are displayed.

Exposure mode

When the *CW emission mode* is set, it is possible to select:

- "Continuous" exposure mode: the emission is started and terminated by pressing and releasing the footswitch.
- "Single Pulse" exposure mode: it is possible to select the laser emission duration (TON): the emission begins when footswitch is pressed and ends when the TON has elapsed or footswitch is released; in order to carry out a new exposure it will be necessary to release the footswitch and then press it once again.

NOTE

The footswitch always has priority:

- by pressing the footswitch the emission begins and the timing of exposition starts;
- when the footswitch is released the emission is immediately interrupted and the initial counting value is reset.

When the *PW emission mode* is set, it is possible to select:

- "Continuous" exposure mode: the pulsed emission is started and terminated by pressing and releasing the footswitch.
- "Single burst" exposure mode: it is possible to select the number of pulses to be performed in a burst; the pulsed emission begins when footswitch is pressed and ends when the number of pulses has been performed or footswitch is released.
- "Repeated bursts" exposure mode: it is possible to select the number of pulses to be performed in a burst and the delay between two consecutive bursts.

See the example below.

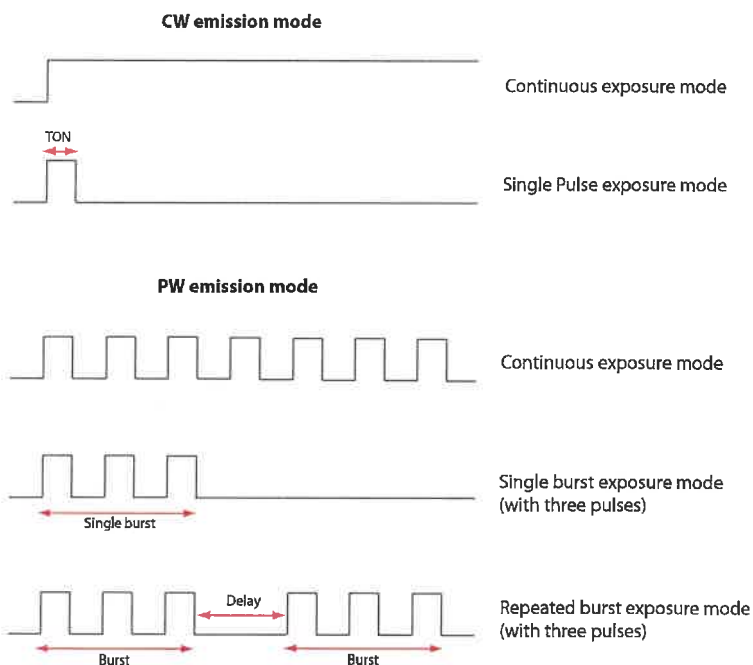

Fig.37 - Diode exposure modes - examples

Total Energy and Total Time

The system displays the energy delivered and the emission time elapsed since the last resetting. When the system is turned on, these counters are set to zero, then they increase during treatment. If the "RESET" option is pressed, the "TOTAL ENERGY" and "TOTAL TIME" values are cleared.

Aiming source

The "Aiming beam" area allows to make the aiming beam always visible during emission (CW option) or to make it blinking during emission (PW option).

8.5. Favorite menu

In both the CO₂ and Diode User Menus, the  icon allows the user to access a list of user-defined favorite treatment parameters. Selecting a favorite parameter set offers the convenience of quickly loading the most used parameter values.



To save a favorite parameter set, first select the desired parameter values in the User Menu (CO₂ or Diode) and then touch the  icon; the system displays the following popup:



Fig.38 - 'Add to favorites' menu

Touch one of the empty rows to select it (the row will be highlighted with a blue background) and then the Save icon : the system displays a summary of selected parameter values as shown in Fig.39.

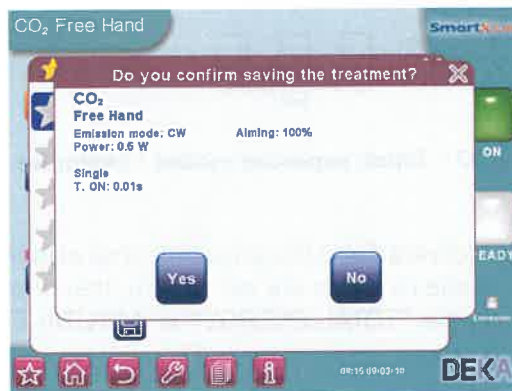





Fig.39 - Summary of parameter values to be saved

If the values are not correct, touch 'No' and modify them, otherwise touch 'Yes' and insert a name for the favorite parameter set: a keyboard will appear to allow the user to enter the information.

On the keyboard, note that the  icon allows the user to switch from upper case to lower case, while the  icon allows the user to enter special characters.

Touch the Save icon to save the set of parameters in the list of favorite parameter sets.

To load one of the parameter sets previously saved amongst the favorites, touch the  icon in the bottom of the screen: the system displays the list of saved favorite parameter sets. Touch the desired row (the row will be highlighted with a blue background), then:

- touch the row again to display a summary of the saved parameters, or
- touch the "USE THESE DATA" button to load that set of parameters.



Fig.40 - Loading a parameter set from list of favorite parameter sets

NOTE: After a favorite parameter set is loaded, any changes made by the user to individual parameter values will not be highlighted by the system.

8.6. Database mode

The "database" mode may contain sets of stored user-defined treatments parameters (i.e., treatment description, delivery system, phototype, fluence and pulse configuration); it offers the convenience of storing important parameters that can be set automatically.

To enter this mode, press the area with the name of the treatment category you want to select in the Home menu or the  key common to all system menus.



Fig.41 - Database mode

For example, by pressing the "ENT" area, it is possible to display the list of all stored treatments for "ENT" category.

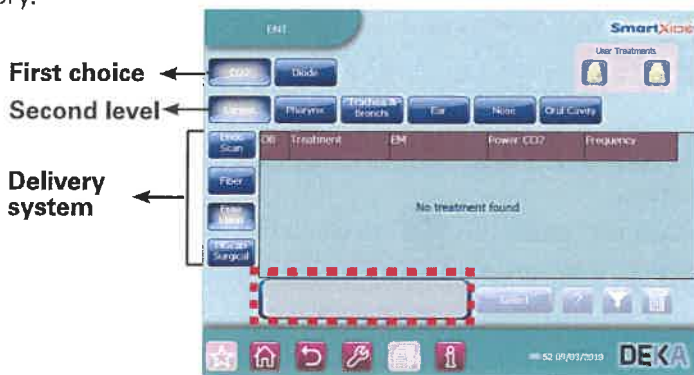





Fig.42 - ENT treatments

The system allows the user to save his own treatments both in a "public" database (identified by  icon) and in a "personal" database (identified by .

The first one is always available both for displaying and modifying the stored treatments; the second type of user-defined database can be entered only if the "User ID" chip is inserted in the proper connector on the system (see par. 7.6.).

Proceed as described below to display the treatments list.

The first choice to make is the database type: user-defined public or user-defined personal. Just press the related button to display the treatments: e.g. to display the personal treatments, press on the "" button.

Then select the type of source (only one selection at a time is possible). If a source is not available, the relevant key is "disabled".

When a source has been selected, the system enables the corresponding keys on the second level, that is the area to be treated or the treatment procedure (according to the selected database category) for which at least one treatment is available.

Depending on the selected option, the available delivery systems are enabled: select the one (by pressing the corresponding area) which you want to see the related treatments of.

The system displays all the available treatments for the selected parameters.



The arrows on the right side allows to page through the treatments list.

Each row of the table corresponds to an available treatment; for each of them the system provides the following information:

- the name of the treatment and the emission parameters: emission mode, power and/or frequency, scanning parameters (in case).
- it is possible to add notes about the selected treatment (both preset and user defined) by pressing the area highlighted in Fig. 42: an "ordinary" keyboard is displayed to allow typing.



Fig.43 - Keyboard

Please note that the "" key allows to switch from capital to small letters while the "" key allows to insert special characters.

Press the "" icon to save changes; press the "" to close the window without saving.

- Moreover, it is possible to "search" along the database of treatments: press the "" icon to filter the list of treatments and select the treatments you want to display.

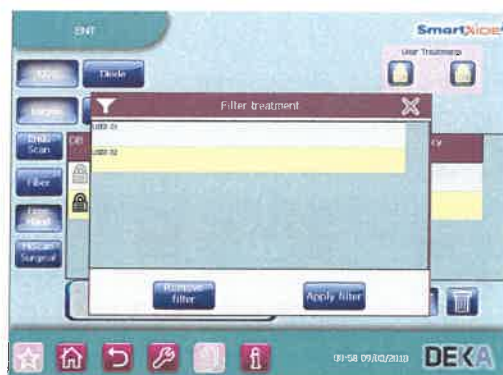



Fig.44 - Database filter

How to select a treatment

- Press the row associated with the treatment to be selected: the row becomes yellow-highlighted.
- Press the **"Select"** key: it allows to set the selected treatment on the device. The type of database, the treatment category, treatment name and the phototype (if applicable) are displayed in the upper part of the User menu.

How to delete a treatment

- Press the row associated with the treatment to be deleted.
- Touch the  icon and confirm

How to save a treatment



- Enter the User mode and select the emission configuration that you want to store.
- Press the  icon: the system displays the menu shown in Fig. 45.



Fig.45 - How to save a treatment

- Select the treatment category, the type of user-defined database (public or personal) where you want to save the treatment and the kind of procedure.
- Press on the "Treatment" area to choose the treatment name. It is possible to choose the name among the ones already available or type a new name. An "ordinary" keyboard, like the one shown in Fig. 43, is displayed to allow typing.
- it is also possible to add notes about the treatment by pressing the **"Note"** field.
- Press the  icon to save: the new treatment parameters will be saved and displayed in the treatments database.

NOTE:

Once the selected treatment has been set on the User menu, if the user modifies a stored parameter, the system highlights with a "*" the modified parameter and allows to restore the stored value by pressing the "Restore" key (displayed in the upper part of the screen when a parameter is changed).

8.7. Set up menu

The Set up menu allows to set the system clock and date, to regulate the brightness of the screen, to select the language and other tasks.

To enter this menu, press the "🔑" area.



Fig.46 - "Set up" menu

From this menu:

- It is possible to choose the time format between 12h and 24h and the date format among dd/mm/yy, mm/dd/yy, yy/mm/dd; to change a parameter, touch the relevant area and act on the corresponding arrows.
- It is possible to change the language.
- It is possible to adjust the sound level of the internal buzzer: press the "+" and "-" keys to adjust the level and the "TEST" key to test the selected level.
- select the time for automatic system switch off between 2 and 20 minutes by pressing "🌐": if the system is left unused for the selected amount of time, it will automatically switch off the laser source in order to extend the service life of the internal components.
- It is possible to change the background colour.
- It is possible to enable/disable the keys sound.
- It is possible to choose an air flow mode for the handpiece by pressing "🌀": continuous (i.e. the air flows continuously when the system is in READY status), and timed with emission (i.e. the air flows when the CO₂ laser source is operating).

If some parameters have been modified, the "💾" icon is displayed to allow to save changes.

8.8. CO₂ power calibration procedure

The SmartXide²TRIO system is equipped with an internal power meter which allows to measure the real output power level of the CO₂ laser source.

The power evaluation and calibration procedure is started and continuously performed as the CO₂ source is switched on.

As the CO₂ source is switched on and each time the power level is changed, the system starts flashing the message "POWER EVALUATION" on the screen in order to warn the operator that a power evaluation and calibration procedure for that power level is in progress.

During this procedure, footswitch is automatically disabled so no laser treatment can be started.

Note that if the READY mode was selected, the system will restore this mode only once the procedure will be completed.

The procedure is intended to verify the real power level provided by the CO₂ laser source and in case make it matching with the power level selected by the operator.

At the end of the procedure, the message "POWER EVALUATION" is cleared.

The following two conditions can occur:

- the real power level matches with the selected power level or the procedure succeeds in making them matching: no further message is displayed and the system is ready to operate;
- the real power level does not match with the selected power level AND the procedure fails in making them matching: in this case, a double warning sound is performed and the real power level currently available is flashed on the screen for about 5s to warn the operator.

After 5s, this value stops flashing and it is taken as the effective treatment power level.

Once the calibration procedure is completed, the SmartXide²TRIO system starts monitoring the real power level in order to detect power fluctuations.

If the real power level changes so that it does not match anymore with the value displayed on the screen, the system acts as follows:

- if a laser treatment is in progress, that is if footswitch is pressed and as long as it is kept pressed, the new power level is displayed on the screen with black characters on white background and the internal buzzer produces 5 sounds per seconds - instead of 1 sound per second - in order to warn the operator;
if the power mismatch is recovered, the old power level is displayed on the screen with standard characters and timed sound is again performed one time per second.
- If no laser treatment is in progress, a double warning sound is performed and the new power level is flashed on the screen for about 5s to warn the operator.
After 5s, this value stops flashing and it is taken as the new effective treatment power level.
- if the detected output power is out of the regulatory limits on respect to the nominal one, the emission is immediately stopped and the system states a HIGH POWER or a LOW POWER alarm - see Section "Troubleshooting" -.

8.9. System shutdown

To shut down the system in a normal (non-emergency) condition, proceed as follows:

- **press the "STAND BY" key on the control panel;**
- turn the key of the key switch to the "O" position.

In an emergency condition, press the emergency switch - see Section "System description" -.

Page intentionally left blank.

9. SCANNING UNITS

The SmartXide²TRIO system can be provided with two different scanning units that can be connected to the articulated arm and that allow to achieve high performance in specific treatments.

The scanning units are listed below:

- "HiScan Surgical" for microsurgery applications
- "Endoscan" for surgical endoscopic and microsurgical applications.

9.1. Installation of the scanning unit

Proceed as follows to install a scanning unit:

- **switch the system off;**
- remove the handpiece from the articulated arm, if connected;
- remove the protection cap (if present) and screw the scanning unit to the articulated arm;
- pull down the protection panel on the rear side of the system to access the connector for the scanning cable and connect it paying attention to make the plug of the cable enter the suitable hole (see Fig. 47);

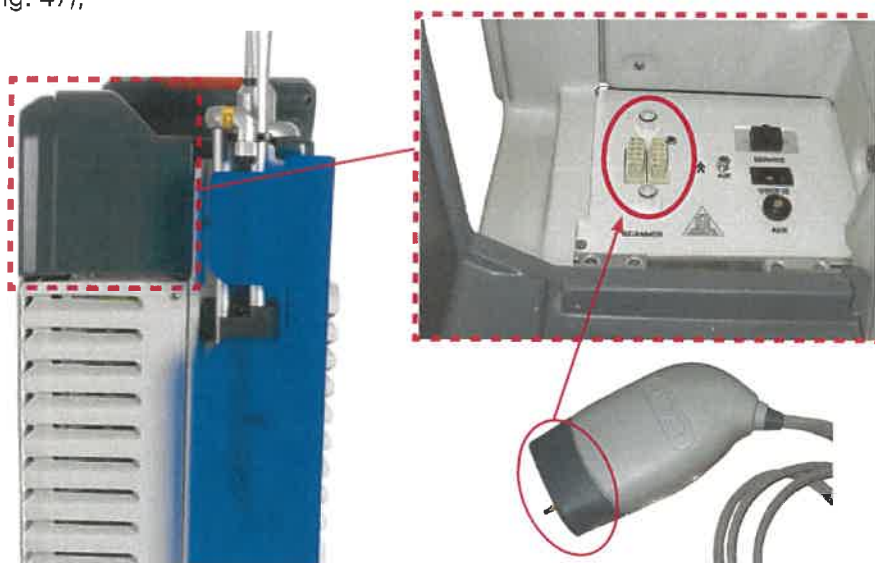

Fig.47 - Connection of the scanning unit

- **only if not already connected**, connect the other side of the cable to the scanning unit: insert the connector so that the red dot marked on it matches with the red dot on the unit connector, as highlighted in the example alongside.



NOTE

When the scanning unit is disconnected from the system, put again the protection cap on it.

ATTENTION - Possible equipment damage

- The scanning cable must be connected/disconnected with the system switched off (the key switch must in the 'O' position).
- **Do not disconnect the scanning head from its cable unless it is absolutely necessary: if it is necessary to remove the scanner, disconnect its cable from the system.**

**CAUTION- Possible risk for patient/operator**

**Each scanning unit has its own cable: be very careful not to exchange the cable with the one of another scanning unit.
If possible, do not disconnect the cable from the scanning head.**

Once a scanning unit is connected, the SmartXide²TRIO system automatically detects its presence and allows to activate it via the control panel.

The area of the currently connected unit is highlighted on the CO₂ main menu.

9.2. Use of the HiScan Surgical unit

An external scanning unit called HiScan Surgical is available among system accessories - optional - and shown in Fig. 48.

The external HiScan Surgical unit can be used either with micromanipulator or with long focal (4" or longer) handpieces. However the use together with the Deka EasySpot Hybrid micromanipulator or similar, is the best choice: please refer to the *Operator's Manual* of the micromanipulator for its description and use.



Fig.48 - HiScan Surgical unit

NOTE

HiScan Surgical is generally provided already connected to Deka micromanipulator: please do not disconnect the two units, if possible. If the two units are disconnected, screw the connector of the HiScan Surgical unit shown as **(A)** on the micromanipulator; connect the micromanipulator cable to its connector on the HiScan unit **(B)**.

To verify that the two units are correctly assembled, perform an emission on a tongue depressor selecting the "hexagon" shape and verifying that the scanning is performed horizontally from top to bottom.

To activate the HiScan Surgical unit, if properly installed, press the "HiScan Surgical" area in the CO₂ main screen. The screen changes as shown in Figure:



Fig.49 - User menu when HiScan Surgical unit is activated

Shapes of the scanning pattern

The scanning unit can generate the following types of patterns: line, arc of a circle up to a complete circumference, ellipsoid motion on a circular surface, hexagon (in "normal" or "interlaced" scan mode), filled circle and spiral.

Touch the relevant icon in the "**Shape**" area to select a scanning shape.

NOTE

The HiScan Surgical unit moves the red aiming beam on the outline of the selected scanning area. This function allows to immediately check the characteristics - shape and dimensions - of the scanning area.

NOTE

A brighter spot on an angle of the hexagon shape indicates the scanning starting point.

ATTENTION!

The ellipsoid motion on a circular surface does not have a uniform delivery of energy on the tissue. Therefore, the "depth" displayed on the screen is an average of the depths of ablated tissue in the whole scanning; moreover, it has to be used with high scanning speed and moving the laser beam on the tissue, to achieve the best result of ablation.

According to the selected shape, the system enables/disables the parameters described in the following paragraphs.

Scanning mode

It is possible to select two different types of scanning **ONLY for the "hexagon" scanning shape**:

- **"Normal"** scan mode
When this scan mode is selected, the area is treated by scanning the lines from left to right and from right to left, starting at the first line from the top to the last line at the bottom.
- **"Interlaced"** scan mode
When this scan mode is selected, the area is treated by first scanning the odd lines and then the even lines. Once the scan of the odd lines has been completed from the top to the bottom the even lines are scanned from the bottom to the top.
The interlaced scan mode is advisable for reducing the thermal effects during treatment.

To select either one or the other scan mode, press the **"Scan Mode"** area (*this area is displayed only when the "hexagon" shape has been selected*).

Size of the scanning pattern

The **"Size"** option allows to change the dimension of the scanning area:

- for all shapes except for spiral, the size is displayed both as a percentage of the maximum available scanning area (i.e. 6.3mm at 400mm focal length) and as size in mm (according to the selected focal length);
- the diameter of the spiral is displayed in mm and can be selected from 0.2mm to 1.1mm (step: 0.1mm).

This parameter is available for all the scanning shapes and can be changed in one of the following ways:

- pressing the **"Size"** area of the User menu and acting on the arrows of the **"Select Dimension"** menu;
- by the **red key** located on the scanning head - see Fig. 48 -;
- by the remote command (central position) on the micromanipulator joystick. The change of the scanning area dimension occurs on releasing the remote command key. By keeping pressed this key for more than 4s, "SCAN OFF" mode is enabled.

See *Micromanipulator Operator's Manual*.

"Curving" parameter

If the "arc of circle" shape has been selected, the "Curving" parameter is enabled in the User menu. The two arrows in this area allow to change this parameter, that is the extension of the selected arc.



Fig.50 - Curving parameter

Its value is expressed as ratio between the subtended arc and the maximum available extension - that is the circumference -.

The pictures below show, for example, the arcs resulting from some values of the "Curving" parameter.



The "Curving" parameter is NOT available for the other scanning shapes.

Rotation of the scanning patterns

The selected scanning shape can be rotated in one of the following ways:

- by the two yellow keys located on the scanning head - see Fig. 48 -;
- by the rotation of the key of the remote command on the micromanipulator joystick. See *Micromanipulator Operator's Manual*.

The selected scanning shape can be rotated also during emission: see the description of "ROWL" parameter in par. "Settings" on page 67.

Emission mode

The area "**Emission mode**" alternately selects and displays either **CW** or **UP** emission mode. Please refer to par. 8.3.1 for details on these two emission modes.

Exposure

The selected exposure mode is displayed on the screen in the "**Exposure mode**" area; touch this area to enter the screen which allows to change the exposure mode.

Three exposure modes can be selected by touching the relevant area:

- continuous - "Contin." on the screen -;
- timed single exposure - "Single" on the screen -;
- timed repeated exposures - "Repeat. " on the screen -.



Fig.51 - Selection of the exposure mode

Note that the emission mode - CW/UP - can be changed regardless of the selected exposure mode.

In **continuous exposure mode**, the exposure time is fully controlled by the operator acting on the footswitch: as long as the footswitch is kept pressed, the shutter is open, the laser emission occurs and the scanning unit repeats the selected pattern.

When this mode is selected, it is also possible to select a finite number of scanings ("**Pass**" parameter on the screen, see Fig. 51): in this case, laser emission is stopped as soon as the selected number is reached. Otherwise, when the symbol  is highlighted (infinite pass), the emission is entirely controlled by the operator.

It is possible to change the "**Pass**" parameter acting on the two arrows. The User menu displays the depth of ablated tissue for each scanning and the total depth once completed all the selected scanings.

When the **single exposure mode** is enabled and the footswitch is pressed, the system opens the shutter and keeps it open only for the time of one complete scanning. Once this time is exhausted, the shutter is automatically closed regardless if footswitch is still pressed.

If the operator wants to perform a new exposure, he has to release and then press again footswitch.

When **timed repeated exposures mode** is enabled and the footswitch is pressed, the system opens the shutter and performs scanning sequences until footswitch is kept pressed.

Once a single scanning is completed, the shutter is automatically closed then, if footswitch is still pressed, the system waits the selected "Delay" time; after this time the shutter is open again and a new scanning is performed. This sequence is continuously repeated as long as footswitch is kept pressed.

Use the arrow keys (Fig. 51) to change the "**Delay**" time between two scans from 0.1s to 5s.

Scanning modes

The HiScan Surgical system allows the operator to use two different working modes available in the "**MODE**" area of the User menu: the "Depth mode" and the "Power mode".

Using the "**Depth mode**", the operator can act directly on two parameters: the **emission power** and the **cutting depth**. According to the selected values for these two parameters and according to the selected focal length, the system automatically calculates the required energy density (fluence). The "Depth" parameter can be changed from 0.2mm to 2mm acting on the two arrows.

Using the "**Power mode**" (*please refer to the User menu shown in Fig. 49 where this mode is selected*), the operator can act directly on two parameters: the **emission power** and the **dwelt time** of the laser beam on a scanning point; according to the selected values for these two parameters and according to the selected focal length, the system automatically calculates the required energy density (fluence) and therefore the cutting depth on tissue: this last parameter is displayed on the User menu.

The "Dwell time" can be changed from 100µs to 45ms acting on the two arrows.

NOTE

If, according to the selected dwell time and power value, the resulting depth is higher than 2mm, the system does not declare this value and shows a warning icon next to the dwell time.



CAUTION - Possible risk for patient/operator

The tissue ablation depth is strictly connected to the type and characteristics of treated tissue, therefore the "Depth" parameter shown on the screen is purely as an indication.

Power selection

The "**Power**" selection keys allow to change the power value from 0.5W to 60W.

Disabling the scanning

If an area is to be treated without scanning, select the "point" shape in the "SHAPES" area of the User menu (without unscrewing the scanning head).

The "point" becomes red highlighted and the selection of the scanning parameters is disabled: the operator can change only the power value, the emission mode and the focal length.

The scanning can be disabled also by keeping pressed for a few seconds the red key on the scanning head (or the central key of the remote command on the micromanipulator joystick) until the red aiming beam stops at the center of the area given by the spacer of the scanning head. The laser pulse will be performed on this point.

As the "**No Scan**" mode is set, the system displays a warning message to remind the operator that it is necessary to manually move the laser beam in order to avoid dangerous overexposures. For this reason the operator can enable an acoustic signal to warn that the "No Scan" status is set: this acoustic warning keeps on until the scanning mode is enabled again.

 **CAUTION- Possible risk for patient/operator**

When the "No Scan" mode is selected, footswitch works in continuous way.



Fig.52 - "No Scan" mode

Aiming source

The intensity of the aiming beam from 1% to 100% (step: 2% between 2% and 10%, step: 10% for the other values).

It is also possible to switch off the aiming beam while lasing: press the "Aiming" area and select the "Down" ("Diode Off while Lasing") option.

Set the "Down" option on to have a clear view of the operating field and well distinguish the ablated tissues during treatment.

 **CAUTION- Possible risk for patient/operator**

CO₂ aiming beam intensities higher than 60% require an optical protection as indicated in par. 5.2.1. The system displays a warning icon next to the selected value (if higher than 60%).

Scanning Info

The system displays further info about scanning, that is the total scanning time and energy according to the selected parameters.

"Free hand" mode

It is always possible to go back to the "Free Hand" mode by pressing the "Free Hand" area: the systems displays a message to warn the operator that the delivery system selection has been changed. Press the "Confirm" key to go back to the User menu.

Settings

The "Settings" window allows the user to access the options needed to set the scanning system correctly and to enable the "Rowl" option.



Fig.53 - "Settings" option

Focal

The "**Focal**" option allows the operator to "inform" the system about the focal length set on the micromanipulator.

Touch the relative area to select the operating focal length of the microscope, then press  to confirm the choice.

**CAUTION- Possible risk for patient/operator**

Be careful to correctly select the focal length because this parameter is used by the system to calculate the scanning area and the cutting depth.
The selected focal length must be the same of the working focal length set on the microscope on which the focus of the micromanipulator was adjusted.

Rowl

The "Rowl" (Rotating on While Lasing) option allows the operator to activate the rotation of the selected scanning shape during laser emission.

The "Rowl" function key is present in the settings windows, when the option is activated the "Rowl" label is shown near the "Settings" key in the User menu.

NOTE

This option is automatically disabled every time the system is switched off.

**CAUTION- Possible risk for patient/operator**

Before starting emission (that is, before pressing the footswitch), be sure that the "Rowl" option is correctly set according to your purpose: if you want to use the rotation without the need to release the footswitch, be sure that the option is enabled because it is automatically disabled when the system is switched off; otherwise, if you don't want to rotate the selected pattern while lasing, be sure that the "Rowl" option is disabled as it could have been previously activated.

The "**Centering correction**" option allows to adjust the laser beam centering, if necessary.

This adjustment doesn't take the place of the alignment procedure of the articulated arm but it just helps when little adjustments are needed before treatment, in order to enter perfectly the most critical accessories like micromanipulators or laparoscopes.

Before starting the surgical procedure the operator has the responsibility to check the coaxiality between the red aiming and CO₂ beams.

In microsurgery procedures this check has to be performed through the microscope and the micromanipulator at the system's working setup; the operator has not to change it after this operation during the surgical procedure.

For further information, please refer to *Micromanipulator Operator's Manual*.

The arrow keys manage the horizontal and vertical motions of the laser beam along the two axes; the "**Restore**" key allows to center the laser beam in the same position set by factory;

the  icon confirms the selected centering.

NOTE

Assuming that the laser arm is correctly aligned, the "**Restore**" option is very important in order to come back to the initial position. It may be useful if the operator "loses" the beam during the centering procedures.

ATTENTION!

If you perform the centering correction procedure without saving the new settings (that is, if you switch off the system before exiting the "Centering correction" menu), at the next system start-up a

warning message is displayed: the user has to perform again the centering procedure before using the scanning unit.

In order to check the accuracy of centering, the system allows to switch on the laser source and perform a laser emission on a target surface using preset parameters (UP, 5W). This operation can be done with the steady point or with the full circle pattern. To switch between the two modes, press the area highlighted in Fig. 53.

NOTE

It is possible to control the horizontal and vertical motion of the laser beam along the two axes also in the following ways:

- press the red key on the scanning head or the central key of the remote control on top of the micromanipulator joystick to select the horizontal or the vertical axes;
- press the two yellow keys on the scanning head or the right-left keys of the remote control on top of the micromanipulator joystick to move the beam.

9.2.1. HiScan Surgical alarms**Hi-Scan**

This fault condition concerns troubles with the HiScan Surgical unit.

Try to reset the fault condition. Call the technical assistance service if it persists.

HS KEYB

On the scanning head there are three keys. The system states a fault condition if one of these keys is pressed when the HiScan Surgical unit is activated. Try to reset the fault condition. If it persists call the technical assistance service.

HS galvo driver

The system states a fault condition if the mirrors inside the HiScan Surgical unit are not properly working. If this fault is stated on HiScan Surgical activation, check all the connections with the scanning unit.

Try to reset the fault condition. If it persists call the technical assistance service.

HS points maker

This fault condition concerns troubles with the software of the HiScan Surgical unit. Try to reset the fault condition. If it persists call the technical assistance service.

EEPROM Factory Centering/EEPROM User Centering

These fault conditions concern problems with the centering procedure data storing. In the first case, call the technical assistance service; in the second case, perform again the centering procedure and, if the problem is not solved, call the technical assistance service.

9.3. Use of the EndoScan unit

Another external scanning unit called EndoScan is available among system accessories - optional - and shown in Fig. 54.

EndoScan can be used either via long focal handpieces (4" or longer), or via DEKA micromanipulator, or via laparoscope.



Fig.54 - EndoScan unit

NOTE

If present, screw the micromanipulator on the connector of the EndoScan unit shown as **(A)** and connect the remote control, if available, to the connector **(B)**.

To activate the EndoScan unit, if properly installed, press the "EndoScan" area in the CO₂ main screen. The screen changes as shown in Figure:



Fig.55 - User menu when the EndoScan unit is activated

Shapes

The scanning unit can generate two types of patterns:

Surface mode (red highlighted in Fig. 55)

A circular surface is covered, with a composed ellipsoid mode.

In this scanning modality, using the UP emission mode, more delicate ablations are obtained.

Perimeter mode

The focused laser beam moves in a circular mode. In this scanning modality the laser becomes a sort of "milling cutter" that ablates each passage a layer of tissue.

In any moment it is possible to stop the scanning movement to pass to the steady spot, just by pressing the dedicated button on the centre of the touch screen.

NOTE

The EndoScan unit moves the red aiming beam on the selected scanning figure. This function allows to immediately check the characteristics - shape and dimensions - of the scanning area.

Size of the scanning pattern

The "Dimen." option allows the user to change the size of the scanning area (displayed as a percentage of the maximum available scanning area,

i.e. 6.3mmx6.3mm at 400mm focal length).



CAUTION- Possible risk for patient/operator

Once the power level has been set, the tissue ablation rate is higher for smaller scanning patterns.

Emission mode

The area "**Emission mode**" alternately selects and displays either CW or UP emission mode. Please refer to par. 8.3.1 for details on these two emission modes.

Scan mode

The system allows to control the exposure time during a laser treatment.

The selected exposure mode is displayed on the screen in the "Exposure" area; touch this area to enter the screen which allows to change the exposure mode.

Three exposure modes can be selected by touching the relevant area:

- continuous - "Contin." on the screen -;
- timed single exposure - "Single" on the screen -;
- timed repeated exposures - "Repeat. " on the screen -.

Note that the emission mode - CW/UP - can be changed regardless of the selected exposure mode.

In **continuous exposure mode**, the exposure time is fully controlled by the operator acting on footswitch: as long as footswitch is kept pressed, the shutter is open, the laser emission occurs and the scanning unit repeats the selected pattern.

When the **single exposure mode** is enabled and footswitch is pressed, the system opens the shutter and keeps it open only for the time of one complete scanning. Once this time is exhausted, the shutter is automatically closed regardless if footswitch is still pressed.

If the operator wants to perform a new exposure, he has to released and then pressed again footswitch.

When **timed repeated exposures mode** is enabled and footswitch is pressed, the system opens the shutter and performs scanning sequences until footswitch is kept pressed.

Once a single scanning is completed, the shutter is automatically closed then, if footswitch is still pressed, the system waits the selected "Delay" time; after this time the shutter is opened again and a new scanning is performed. This sequence is continuously repeated as long as footswitch is kept pressed. Use the arrow keys to change the "delay" time between two scans from 0.1s to 5s.

Power

The "**Power**" selection keys allow to change the power value from 0.5W to 60W.

Dwell Time

Only if the circular scanning pattern is selected, the "DwellTime" parameter, that is length of time that the laser beam stays on a scanning point, can be selected from 100µs to 1000µs.

"No Scan" scanning mode

Touch the "**No Scan**" option in the "Shapes" area to select this scanning mode: this area becomes red highlighted while all the scanning parameters are disabled except the emission mode.

The scanning can be disabled also by keeping pressed for a few seconds the central key on the scanning head (or the central key of the remote command on the micromanipulator joystick) until the red aiming beam stops at the center of the scanning area. The laser pulse will be performed on this point.

If the "No Scan" scanning mode is selected, the system emits a fixed laser beam, without scanning.

Aiming source

The intensity of the aiming beam from 1% to 100% (step: 2% between 2% and 10%, step: 10% for the other values).

It is also possible to switch off the aiming beam while lasing: press the "Aiming" area and select the "Dowl" ("Diode off while lasing") option.

Set the "Dowl" option on to have a clear view of the operating field and well distinguish the ablated tissues while operating.



CAUTION- Possible risk for patient/operator

CO₂ aiming beam intensities higher than 60% require an optical protection as indicated in par. 5.2.1. The system displays a warning icon next to the selected value (if higher than 60%).

"Free hand" mode

It is always possible to go back to the "Free Hand" mode by pressing the "Free Hand" area: the systems displays a message to warn the operator that the delivery system selection has been changed.

Press the "Confirm" key to go back to the User menu.

Adjusting of the laser beam centering

The "Centering correction" option allows to adjust the laser beam centering, if necessary.

This adjustment doesn't take the place of the alignment procedure of the articulated arm but it just helps when little adjustments are needed before treatment, in order to enter peectly the most critical accessories like micromanipulators or laparoscopes.

Before starting the surgical procedure the operator has the responsibility to check the coaxiality between the red aiming beam and CO₂ beam.

In microsurgery procedures this check has to be performed through the microscope and the micromanipulator at the system's working setup; the operator has not to change it after this operation during the surgical procedure. For further information, please refer also to *Micromanipulator Operator's Manual*.

The arrow keys manage the horizontal and vertical motion of the laser beam along the two axes; the "Restore" key allows to center the laser beam in the same position set by factory;

the "Confirm" icon confirms the selected centering.



Fig.56 - EndoScan centering correction

NOTE

Assuming that the laser arm is correctly aligned, the "Restore" option is very important in order to come back to the initial position. It may be useful if the operator "loses" the beam during the centering procedures.

ATTENTION!

If you perform the centering correction procedure without saving the new settings (that is, if you switch off the system before exiting the "Centering correction" menu), at the next system start-up a

warning message is displayed: the user has to perform again the centering procedure before using the scanning unit.

NOTE

It is possible to control the horizontal and vertical motion of the laser beam along the two axes also in the following ways:

- press the central key on the scanning head or the central key of the remote control on top of the micromanipulator joystick to select the horizontal or the vertical axes;
- move right-left the central key on the scanning head or the right-left keys of the remote control on top of the micromanipulator the joystick to move the beam.

In order to check the accuracy of centering, the system allows to switch on the laser source and perform a laser emission on a target surface using preset parameters (UP, 5W).

This operation can be done with the steady point or with the full circle pattern. To switch between the two modes, press the area highlighted in Fig. 56.

ATTENTION!

If you are performing the centering procedure with the scanning unit connected to a laparoscope, use the circle pattern: the laser beam is correctly centered only if you see the full circle (not an arc of circle) through the laparoscope (projecting the aiming beam on a perpendicular plane surface). The correct centering has to be verified every time the laparoscope is connected to the EndoScan unit.

Scanning Info

The system displays further info about scanning, that is the total scanning time and energy according to the selected parameters.

9.3.1. EndoScan alarm**EndoScan**

This fault condition is displayed by the "SYSTEM FAULT" menu if the SmartXide²TRIO system detects troubles about the EndoScan unit.

Make sure that the scanning unit is properly connected. Try to reset the fault condition; call the technical assistance service if the fault persists.

EEPROM Factory Centering/EEPROM User Centering

These fault conditions concern problems with the centering procedure data storing.

In the first case, call the technical assistance service; in the second case, perform again the centering procedure and, if the problem is not solved, call the technical assistance service.

Page intentionally left blank.

10. CLINICAL APPLICATION

This section discusses the clinical application of the system in general terms; it is not intended to be an exhaustive clinical manual.

10.1. CO₂ laser clinical application

Laser applications and interventions evolved rapidly in the last three decades. Laser systems are nowadays being used extensively in all fields of surgery, and in particular of otorhinolaryngology, gynaecology and dermatology. Current developments are focused on modes of emission and intelligent laser power control as well as the application of laser energy with scanning technology. The CO₂ is the election laser in most medical fields, thanks to its optical property of being absorbed mostly by water it has excellent tissue cutting properties with very little lateral tissue damage (about 50µm, with superpulsed systems and scanners).

The carbon dioxide (CO₂) emits at 10.6 µm, in the far invisible infrared region. As CO₂ radiation is invisible, a visible (typically red) aiming beam laser is accurately superimposed on to the path of the CO₂ beam.

The CO₂ radiation arrives to the accessory passing through an articulated arm with mirrors inside of it, better if 7.

The accessories for the CO₂ laser are always optical devices, single lens, groups of lenses (like zooms). This devices serve to focalize the beam on little spots. The more the spot is little, the more energy density (fluence) can be achieved even using low power, thus permitting a tissue ablation with minimal charring. The attachment with micromanipulators allows coaxial delivery of the energy for laser surgery with operating microscopes, thus extending its range of clinical application considerably, making its use more and more refined. With the zoom of the micromanipulator the focal point can change and be set on the surgical working plane. Thus the operator has to know how to focalize and work with it, specially with an electronic scanner that produces his best effects if working with a peectly focalized laser, in regime of photoablation.

Please refer also to *Micromanipulator Operator's Manual*.

10.1.1. Contraindications

There are no known contraindications for the use of the system, apart general contraindications as in standard surgery.

Generally, contraindications to using the carbon dioxide laser include an inability to visualize the area to be treated because of anatomic considerations (e.g., prolapsing lateral vaginal sidewall, larynx anatomic conformation) and inadequate physician training or experience.

10.1.2. Side effects

Complications, though rare, can occur according to the anatomic district or the surgical procedure. Generally speaking, they can be: blood spill, swelling, discomfort or moderate pain, abnormal cicatrization, adhesions.

The patient must understand the importance of pre-treatment and post-treatment instructions, and that failure to comply with these instructions may increase the probability of complications.

Both bacterial and viral infections are potential side effects if proper clinical precautions are not observed; these precautions are related to the kind of surgical procedure.

10.1.3. Precautions

**CAUTION- Possible risk for patient/operator**

- **Beam alignment and focalization checks are extremely important for safe and correct operation: carefully check if the CO₂ laser beam is properly focused at the microscope's operative working distance and check the coaxiality between the red aiming beam and CO₂ beam.
Do not use the laser if aiming and treatment beams are not coincident.**
- **Spot size and laser energy are independently controlled. If a smaller spot size is used, as in excision procedures, the operator must remember that the energy density is higher. Laser parameters should be employed with extreme caution until you understand the biological interaction between the laser energy and tissue.**

The beam should be moved manually or through the scanning system, if present, to control the ablation depth.

- Plastic instruments such as speculums or eye shields can melt when impacted by the laser beam. Use only stainless steel surgical instruments designed specifically for laser use.
- If necessary, the area around the target site can be protected with wet towels or gauze sponges or laser beam backstops. Ensure that sponges do not dry!
- Be especially careful with the use of oxygen. Oxygen accelerates both the severity and the extent of fire. Always refer to the protocols related to anaesthesia, in force in the hospital where the laser system is used.
- Use non-flammable substances for uses as anesthesia, preparing soft tissue for treatment, and cleaning or disinfecting instruments.
- The solvents of adhesives and flammable solutions used for cleaning and disinfecting should be allowed to evaporate before the laser equipment is used.
- Keep a minimum of combustible materials in the treatment room. If treatment requires the use of a combustible material, such as gauze, first soak it in water.

**CAUTION- Possible risk for patient/operator**

- **Prevent singeing or burning when treating an area with hair by wetting the area with water or saline before beginning treatment.**
- **Attention should also be drawn to the danger of ignition of endogenous gases. When procedures are performed in the perianal area, moistened sponges should be inserted into the rectum.**

**CAUTION- Possible risk for patient/operator**

Always use laser-resistant, cuffed, and flexible stainless steel endotracheal tube. The endotracheal tube cuff can be inflated with saline to protect it from inadvertent penetration. The saline can be dyed with methylene blue so that evidence of cuff-penetration by the laser will readily appear on surrounding gauze sponge.

10.1.4. Pretreatment Recommendations

At the time of the initial visit, the physician should determine the suitability of the laser treatment and inform patients about the treatment.



CAUTION- Possible risk for patient/operator

If using the laser with micromanipulator, before starting the surgical procedure the physician has the responsibility to check if the CO₂ laser beam is properly focused at the microscope's operative working distance and to check the coaxiality between the red aiming beam and CO₂ beam.

The physician has not to change the microscope's working distance after the focusing operation and/or during the surgical procedure.

10.1.5. Treatment Recommendations



CAUTION- Possible risk for patient/operator

Adjust the appropriate maximum joystick's operating field using the dedicate adjustment screw before starting the procedure, in a way that the beam does not exceed the microscope's operating view.

This guarantees the laser beam will never get out of the visual field eventually being "lost" by the operator.

10.1.6. Posttreatment Recommendations



CAUTION- Possible risk for patient/operator

After each treatment session, physicians should advise their patients on proper care of the treated area according to the surgical discipline or procedure.

Patient has to contact the physician if there is any indication of infection (redness, tenderness or pus).

10.2. Diode laser module clinical applications

10.2.1. General description

Diode lasers are transmitted by flexible optical fibers, for this reason they are an alternative to the CO₂ laser for the anatomic districts not easily reachable and where a more coagulative power is needed.

Diode laser module of SmartXide² TRIO is thus a completion of the CO₂ laser wavelength. CO₂ laser though, coupled with micromanipulator and scanner, remains the best choice for precision surgical procedures.

Diode laser modules available to be mounted on SmartXide² TRIO are of 980nm and 940nm, both with 50W maximum power.

These wavelengths are in the near infrared region, having a good haemostasis thanks to the high absorption by water and hemoglobin; this allows a bloodless operating field.

CO₂ laser (10,600nm) is absorbed essentially by water. This characteristic make it excellent for

cutting tissues more precisely than diode lasers but with a less important coagulation property.

10.2.2. Clinical applications

The device is not indicated to be used for Prostate Ablation procedure.

Diode laser can be used in open surgery, as well as in endoscopic applications; in contact and non contact mode.

In contact mode the tip of the fiber is placed directly on the surface of the tissue. This mode is effective, depending on the power density, for both photocoagulation and vaporization of tissue. At the low- or mid-power range, coagulation occurs; at a higher level, vaporization occurs.

In non contact mode the tip of the fiber remains several millimeters apart from the tissue. This mode is largely used for tissue coagulation.

10.2.3. Contraindications

There are no contraindications for diode laser surgical applications, apart from general contraindications as in standard surgery.

10.2.4. Collateral effects

The complications of the laser therapy are the same as for whichever surgical procedure. Some of these complications could be serious.

Pain: the persistency of pain after laser therapy is usually very low, but it depends on the kind of surgical operation.

Sepsis: the possibility of infections must be taken into consideration and treated as in any other surgical operation. The interaction of laser with tissues sterilises only the treated area.

Bleeding: The coagulation is one of the effects on tissue performed by laser. The eventuality of postoperative bleeding can be a consequence of tissue relaxation. The control of the post-operative bleeding can be done by the evaluation of the hematocrite and proper dressings.

Fluids Accumulations: a light edema and minimum variations of the electrolyte can be found after a long duration procedure and drug giving.

Fire: The inhalation of inflammable anaesthetics must be avoided. The oxygen level must not exceed 40%.

11. TROUBLESHOOTING

This sections describes the faults detected by the system and provides a troubleshooting of some problems that can be identified and solved by the operator.

11.1. Faults management

The SmartXide²TRIO system is able to detect fault conditions that may be dangerous for the subject under treatment and for the system itself.

As soon as one of these conditions is detected, the system automatically switches to safety mode: shutter closed, source turned off (STAND BY), footswitch disabled.

The SYSTEM FAULT menu is immediately displayed on the screen.

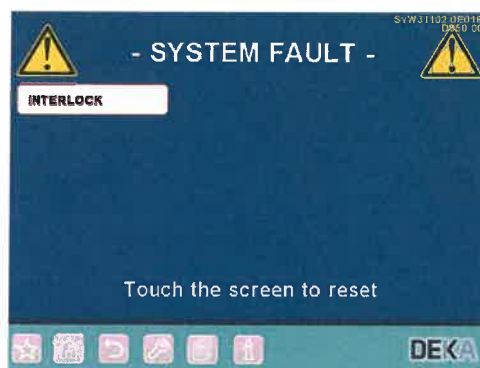

Fig.57 - "SYSTEM FAULT" menu

The SmartXide²TRIO system displays only the currently detected fault conditions - i.e. in figure an INTERLOCK fault was detected -.

Moreover, once a fault is detected, the system keeps on displaying the label even if the fault is solved: this allows the operator to record the detected faults to eventually inform the technical assistance service.

11.2. Descriptions of Faults

The possible faults and the appropriate actions to take are detailed below.

11.2.1. Interlock

This fault is displayed if the INTERLOCK system detects an open circuit.

If the INTERLOCK feature is attached to an external interlock device, check that the door is closed, that the external interlock device is functioning and that the cable from the external interlock device is properly attached to the INTERLOCK socket on the system.

If an external interlock device is not used, check that the INTERLOCK connector (provided with the system accessories) is properly attached to the INTERLOCK socket.

Reset the fault display. Call Technical Service if this fault persists.

11.2.2. Temperature

This fault is displayed if the temperature of the cooling fluid inside the CO₂ laser source or the temperature of the high voltage power supply unit gets too high.

Do not turn off the system in order to let the cooling fluid cool down.

Wait approximately 2 minutes, and then press any key to reset the fault display. Call Technical Service if this fault persists.

11.2.3. Shutter

This fault condition is displayed if the shutter's detected position is not the same as the shutter's expected position. Press any key to reset the fault display.
Call Technical Service if this fault persists.

11.2.4. High voltage

This fault condition is displayed if the internal high voltage power supply unit is not properly working. Press any key to reset this fault display, then switch on the laser source again. Call Technical Service if this fault persists.

11.2.5. Flow

This fault condition is displayed if low flow in the cooling circuit is detected.
Press any key to reset the fault display.
Call Technical Service if this fault persists.
Only Deka technical assistance service or skilled personnel authorized by Deka may service the cooling circuit.

11.2.6. High power/Low power

These two fault conditions are stated if the power evaluation procedure detects a wrong output power level.
The "High power"/"Low power" label is displayed in the SYSTEM FAULT menu in the same location of "High current" alarm.
Carefully read par. 8.3..
Reset the fault condition, then try to switch on the laser source in order to perform once again the power evaluation procedure.
Call the technical assistance service if the fault persists.

11.2.7. EEPROM/Data Memory

These fault conditions are stated if an internal memory component does not work properly.
It can be stated at the start up of the system or when the CO₂ laser source is switched off - STAND BY key pressed -.
These faults are not critical as concerns the performances of the system but there might be problems with the management of the treatment programs that is the system might forget the changes made by the operator to the treatment programs.
Try to reset the fault condition, if it persists call the technical assistance service.

11.2.8. Diode fiber

This fault condition is displayed if the fiber is not properly connected to the system (if the operator is currently using the diode laser source).
Connect the fiber or check the fiber connection. Press any key to reset the fault display. Call Technical Service if this fault persists.

11.2.9. Ick Fiber

This fault condition is displayed if the fiber's identification connector is not properly connected to the system (if the operator is currently using the diode laser source).
Connect it or check if it is properly connected. Press any key to reset the fault display. Call Technical Service if this fault persists.

11.2.10. High/Low Diode Temperature

This fault condition is stated if a diode laser source temperature is out of the operating range.
Do not turn the system off in order to let the system reach the ambient temperature. Wait

approximately 2 minutes, and then press any key to reset the fault display.
Call in any case the technical assistance service and inform them of the problem.

11.2.11. Diode Voltage/Diode Current/Diode Status

This fault condition is stated if the system detects a wrong output voltage/current/status level of the diode laser source.

Try to reset the fault condition, if it persists call the technical assistance service.

11.2.12. High/Low Diode power

This fault condition is stated if the diode laser source power is out of the operating range.

Try to reset the fault condition, if it persists call the technical assistance service.

11.2.13. Communication

This fault condition is displayed if there is a communication problem between the CPU board and the diode driver board.

Press any key to reset the fault display. Call Technical Service if this fault persists.

11.2.14. Driver

This fault condition is stated if the driver board that controls the diode laser source does not work properly.

Try to reset the fault condition, if it persists call the technical assistance service.

11.2.15. High/Low driver temperature

This fault condition is stated if diode laser source driver temperature is out of the operating range.

Try to reset the fault condition, if it persists call the technical assistance service.

11.2.16. Diode controller

This fault condition is stated if the system detects problem with the diode controller.

Try to reset the fault condition, if it persists call the technical assistance service.

11.2.17. CO₂ PSTEMP

This fault condition is stated if overheating of the CO₂ power supply temperature is out of the operating range.

Try to reset the fault condition. If the fault persists, call the technical assistance service.

11.2.18. CO₂ Power Supply

This fault condition is stated if the system detects problem with the CO₂ power supply.

Try to reset the fault condition, if it persists call the technical assistance service.

11.2.19. CO₂ DUTY

This fault condition is stated if the system detects an internal fault generated by the CO₂ power source. Try to reset the fault condition, if it persists call the technical assistance service.

11.2.20. Flip Mirror

This fault condition is stated if the system detects a wrong positioning of the flip mirror which directs the CO₂ laser beam on the articulated arm/fiber.

Try to reset the fault condition, if it persists call the technical assistance service.

11.2.21. High Fiber Temperature

This fault condition is stated if CO₂ fiber temperature is too high (>50°C on the fiber coupling).

Try to reset the fault condition, if it persists call the technical assistance service.

11.2.22. Air Pressure

This fault condition is displayed if the air pressure at CO₂ fiber output is insufficient. Verify that all the air pipes (both the ones of the antibacterial filter and, if present, the one of the external air flow) are properly connected. Press any key to reset the fault display. Call Technical Service if this fault persists.

11.2.23. FIBER

This fault condition is displayed if the CO₂ fiber is not properly connected to the system. Connect the fiber or check the fiber connection. Press any key to reset the fault display. Call Technical Service if this fault persists.

11.3. Warnings

If the system detects power fluctuations, the power level on the screen may be displayed with yellow characters instead of red characters once calibration is completed. If laser treatment is in progress when this occurs, the warning tone rate increases. These two conditions are warnings, not fault conditions. The system does not go into standby and the operator can continue with the laser treatment.

11.4. Troubleshooting

Following is a brief troubleshooting of some problems that can be identified and solved by the operator.

System does not turn on

- Make sure the mains cable is properly connected and the mains voltage/current values match with the specifications of the system.
- Check if the key switch, the emergency switch and the circuit breaker are correctly positioned.

Nothing happens as footswitch is pressed

- Make sure the system is in the OPERATE state - see the Section "System description" -.
- Make sure footswitch is properly connected to the suitable connector - see the Section "System description" -.

Poor laser emission or no laser emission from the delivery system

- Call for Technical Assistance Service.

Aiming beam and CO₂ beam not coaxial

- Make sure the articulated arm was properly installed.
- The problem may be due to a misalignment of the articulated arm: call Technical Assistance Service.

Power displayed after calibration is different from power selected.

- System cannot provide the selected power.
Read carefully par. 8.7.

System does not detect the scanning unit presence

- Make sure the scanning unit is properly connected.
Read carefully the relevant Sections.

For any further problem contact your agent or contact:

DEKA M.E.L.A. s.r.l.

Via Baldanzese 17
50041 Calenzano (Firenze) - Italy
Tel. (+39) 055 8874942
Fax (+39) 055 8832884
Email: info@dekalaser.com

12. MAINTENANCE

12.1. Ordinary maintenance

12.1.1. Laser Care and Handling

Deka suggests that the operator periodically clean and disinfect the exterior of the laser system in the following manner:

- Clean the exterior of the laser with a mild soap and water.
- Use a soft cloth for both cleaning and disinfecting.
- When necessary, disinfect the exterior parts of the equipment with a hospital-grade disinfectant.
- Periodically, remove and vacuum the air filter located on the back of the unit (please refer to par. 12.1.7).

Precautions

- Take care that detergent does not penetrate cavities or apertures of the device;
- do not use chemical solvents and/or abrasive detergents;
- do not use alcohol to clean the surface of the display.

12.1.2. CO₂ reusable parts reprocessing

ATTENTION!

Please refer to the proper CO₂ fiber's instruction for correct maintenance procedures.

CO₂ handpieces have to be reprocessed after use. Proper handling and reprocessing of reusable parts for next patient has to be done by carefully adhering to reprocessing steps described below:

Limitations on reprocessing:

Repeated processing has minimal effect on these components. End of life is normally determined by wear and damage due to use.

A) Start cleaning of reusable parts as soon as possible after use.

B) Wear heavy-duty rubber gloves, a plastic apron, eye protection, and mask during reprocessing.

C) Precleaning at the point of use

Prior to thoroughly cleaning, remove visible soil.

A deep container, e.g. a bucket, containing a wire-mesh basket can be filled with tap water at 22°C to 43°C (72°F to 110°F) and enzymatic detergent (protease formula that dissolves proteins), such as Endozime® AW Triple Plus with APA.

This detergent has to be used in accordance with the detergent manufacturer's directions (e.g., dilution/concentration, temperature, water quality, soak time).

The parts are placed in the wire basket, agitated for 3-5 minutes, and then lifted out.

The basket is overturned onto a table or tray in order to separate the items prior to cleaning, packing and autoclaving.

D) Disassembling the reusable parts

Disassemble the items as described below:

Disassembling the CO₂ handpieces

1. disconnect the air pipes from the handpiece body
2. If connected, unscrew the handpiece from the articulated arm
3. Extract the lens assembly currently connected unscrewing it
4. Pull the spacer out

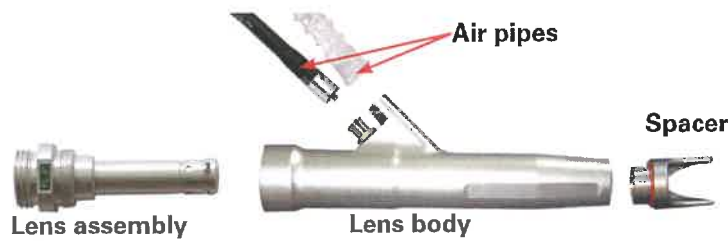

Fig.58 - Disassembling the CO₂ handpieces

Disassembling the CO₂ 2" dental handpiece

1. Disconnect the air pipe from the handpiece
2. If connected, unscrew the handpiece from the articulated arm
3. Unscrew the aperture currently connected

To reassemble the handpiece, reverse the steps.

E) Thorough cleaning

Thorough cleaning allows the removal of all foreign material (dirt and organic matter) from the parts being reprocessed and must always precede sterilization procedures.

If instruments and other items have not been cleaned, sterilization may not be effective because microorganisms trapped in organic material may survive sterilization.

Steps for thorough cleaning

1. Soak the instruments in a container deep enough for the number of items, filled with a solution of tap water at 22°C to 43°C (72°F to 110°F) and the same enzymatic detergent used for precleaning (**step C**).
2. Scrub items vigorously to completely remove all foreign material using the brushes provided with the accessories. Hold items under the surface of the water while scrubbing and cleaning to avoid splashing.
3. Be sure to brush in the grooves and joints where organic material can collect and stick.
4. Rinse items 2-3 minutes thoroughly with tap water to remove all detergent. Please adhere to the suggested rinse time as it ensures that residues remaining on the item do not exceed safe levels.
5. Inspect items visually to confirm that they are clean. If any visible debris remains, repeat steps 2-4.

F) Sterilization

For steam sterilization the following protocol is recommended:

1. Package each component with self sealing pouches suitable for steam sterilisation made of medical paper (heavyweight 70 gsm) and transparent 2-ply laminate. Pouches are available in the following dimensions (they have to be large enough hold items without stressing the pouch seals):
 - 2¼" x 4" / 60mm x 100mm
 - 3½" x 8" / 90mm x 200mm
 - 5¼" x 14" / 135mm x 360mm
 - 7½" x 13" / 190mm x 330mm.
2. Arrange all wrapped items in the chamber of the autoclave in a way that allows the steam to circulate freely. **DO NOT STACK.**
3. Follow the manufacturer instruction for operating the autoclave. Set the autoclave parameters as follows, according to the autoclave type:

- 1) Pre-vacuum cycle: 132°C, 4 minutes, minimum drying time: 5 minutes.
- 2) Gravity cycle: 132°C, 10 minutes, minimum drying time: 5 minutes.

ATTENTION:

The autoclave should be checked each time it is used in order to make sure that it is functioning properly. Follow the manufacturer's instructions whenever possible since autoclave maintenance varies depending on the type of autoclave.

G) Post-processing handling

1. Do not store packs items until they cool to room temperature.
2. Store items using the following guidelines:
 - Store items in a closed, dry, cabinet with moderate temperature and low humidity in an area that is not heavily trafficked.
 - A wrapped pack can be considered sterile as long as it remains intact and dry. When in doubt about the sterility of a pack, consider it contaminated and re-sterilize the items.
3. Reassemble the items before use, reversing the steps previously described (phase **D**).

H) Inspection and Function Testing:

- All parts: visually inspect for damage and wear (i.e. breakage, deformation, crack, scratch).
- Connections: check for compromised connection between parts (hard to connect, loose connection)
- Aiming beam: check for spread beam, non-visible beam.

In case one or more of the above listed criticalities arises, do not use the subject component.

12.1.3. Diode reusable parts reprocessing

The following reusable parts have to be reprocessed after use:

- Diode handpieces;
- Cannulas;
- Fiber cutter;
- Fiber stripper.

Limitations on reprocessing:

Repeated processing has minimal effect on these components. End of life is normally determined by wear and damage due to use.

Proper handling and reprocessing of reusable parts for next patient has to be done by carefully adhering to reprocessing steps described below:

- A)** Start cleaning of reusable parts as soon as possible after use.
- B)** Wear heavy-duty rubber gloves, a plastic apron, eye protection, and mask during reprocessing.

C) Precleaning at the point of use

Prior to thoroughly cleaning, remove visible soil.

A deep container, e.g. a bucket, containing a wire-mesh basket can be filled with tap water at 22°C to 43°C (72°F to 110°F) and enzymatic detergent (protease formula that dissolves proteins), such as Endozime® AW Triple Plus with APA.

This detergent has to be used in accordance with the detergent manufacturer's directions (e.g., dilution/concentration, temperature, water quality, soak time).

The parts are placed in the wire basket, agitated for 3-5 minutes, and then lifted out.

The basket is overturned onto a table or tray in order to separate the items prior to cleaning, packing and autoclaving.

D) Disassembling the reusable parts

Disassemble the items as described below:

Disassembling the diode handpiece

1. Unscrew the tapered proximal end of the handpiece (highlighted in Fig. 59) three to four turns, and then withdraw the fiber.
2. Remove the cannula from the handpiece by unscrewing it.



Fig.59 - Disassembling the diode handpiece

NOTE

Fibers can be either single use or reusable: please refer to manufacturer's instructions.

Disassembling the diode dental handpiece

1. Unscrew the ring nut highlighted in Fig. 60 three to four turns, and then withdraw the fiber.
2. Remove the tip from the handpiece.



Fig.60 - Disassembling the diode dental handpiece

NOTE

Fibers can be either single use or reusable: please refer to manufacturer's instructions.

E) Thorough cleaning

Thorough cleaning allows the removal of all foreign material (dirt and organic matter) from the parts being reprocessed and must always precede sterilization procedures.

If instruments and other items have not been cleaned, sterilization may not be effective because microorganisms trapped in organic material may survive sterilization.

Steps for thorough cleaning

1. Soak the instruments in a container deep enough for the number of items, filled with a solution of tap water at 22°C to 43°C (72°F to 110°F) and the same enzymatic detergent used for precleaning (**step C**).
2. Scrub items vigorously to completely remove all foreign material using the brushes provided with the accessories. Hold items under the surface of the water while scrubbing and cleaning to avoid splashing.
3. Be sure to brush in the grooves and joints where organic material can collect and stick.
4. Flush through lumens with an adapted water jet (e.g., using a syringe).
5. Rinse items 2-3 minutes thoroughly with clean water to remove all detergent. Please adhere to the suggested rinse time as it ensures that residues remaining on the item do not exceed safe levels.
6. Inspect items visually to confirm that they are clean. Inspect items visually to confirm that they are clean. If any visible debris remains, repeat steps 2-4.

F) Sterilization

For steam sterilization the following protocol is recommended:

1. Package each component with self sealing pouches suitable for steam sterilisation made of

medical paper (heavyweight 70 gsm) and transparent 2-ply laminate. Pouches are available in the following dimensions (they have to be large enough hold items without stressing the pouch seals):

- 2¼" x 4" / 60mm x 100mm
- 3½" x 8" / 90mm x 200mm
- 5¼" x 14" / 135mm x 360mm
- 7½" x 13" / 190mm x 330mm.

2. Arrange all wrapped items in the chamber of the autoclave in a way that allows the steam to circulate freely. **DO NOT STACK.**
3. Follow the manufacturer instruction for operating the autoclave.
Set the autoclave parameters as follows, according to the autoclave type:
 - 1) Pre-vacuum cycle: 132°C, 4 minutes, minimum drying time: 5 minutes.
 - 2) Gravity cycle: 132°C, 10 minutes, minimum drying time: 5 minutes.

ATTENTION:

The autoclave should be checked each time it is used in order to make sure that it is functioning properly.

Follow the manufacturer's instructions whenever possible since autoclave maintenance varies depending on the type of autoclave.

G) Post-processing handling

1. Do not store packs items until they cool to room temperature.
2. Store items using the following guidelines:
 - Store items in a closed, dry, cabinet with moderate temperature and low humidity in an area that is not heavily trafficked.
 - A wrapped pack can be considered sterile as long as it remains intact and dry. When in doubt about the sterility of a pack, consider it contaminated and re-sterilize the items.
3. Reassemble the items before use, reversing the steps previously described (phase **D**).

H) Inspection and Function Testing:

- All parts: visually inspect for damage and wear (i.e. breakage, deformation, crack, scratch).
- Connections: check for compromised connection between parts (hard to connect, loose connection)
- Aiming beam: check for spread beam, non-visible beam.

In case one or more of the above listed criticalities arises, do not use the subject component.

12.1.4. Inspect, clean and disinfect the scanning units

Before and after each use, inspect the scanning unit (HiScan Surgical, EndoScan) for dirt or damages. Failure to clean or improperly cleaning can alter the efficiency of the system.

Proceed as follows:

- **Switch the system off and disconnect the scanning unit from the laser system before inspection/cleaning/disinfecting.**
- To clean and disinfect the external surface of the scanning unit, use a cloth dampened with a hospital grade disinfectant.
- Dry with a clean cloth. Do not use the scanning unit until its surface is completely dry, that is the disinfectant solution is fully evaporated.
- Do not use disinfectants containing peracetic acid or chlorine.

12.1.5. Inspecting the diode fiber

- Inspect the end of the fiber to verify it is properly cleaved.
- Inspect the end of the fiber for degradation, charring and other damage. If there is damage at the end of the fiber, the fiber must be cleaved as indicated below.

Stripping and Cleaving the diode optical fiber

Stripping

1. To strip, insert the distal end of the fiber into the stripper. Squeeze the levers on both sides of the stripper evenly until they stop moving. Release the levers and remove the fiber from the stripper.
2. Remove the buffer by carefully sliding the cut length of buffer along the fiber toward the distal end. The length of the bare fiber should be approximately equal to the length of the cannula to be used, plus 3 inches.

Cleaving

1. To cleave the fiber, place the bare fiber on a clean, hard surface. Using the stylus, lightly score a line across the fiber using a single perpendicular stroke. See Fig. 61.

CAUTION: Be careful not to break the fiber during this operation, just score it.

2. Holding the bare fiber between the thumb and forefinger of each hand, close to either side of the score, bend the fiber until it snaps. Properly scored fibers will snap with minimal force.

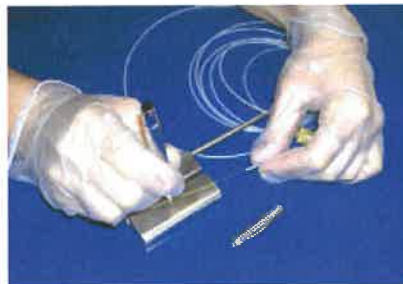

Fig.61 - Scoring the fiber

12.1.6. Fiber care



CAUTION- Possible risk for patient/operator

Read carefully the instructions enclosed with the fiber.

12.1.7. Antibacterial filter check and cleaning

The antibacterial filter must be inspected before each use and must be replaced periodically. The filter life depends on the frequency and conditions of use. If the filter is dirty or if you notice a decrease in the air flow, it must be replaced.

To replace it, just pull down the little protection panel on the rear side of the system, disconnect the two plastic pipes and connect the new filter assembly: place the filter's face with the "IN" label pointed towards the IN connector on the system (highlighted by the red arrows).



CAUTION- Possible risk for patient/operator

Always disconnect the system from the mains before cleaning.

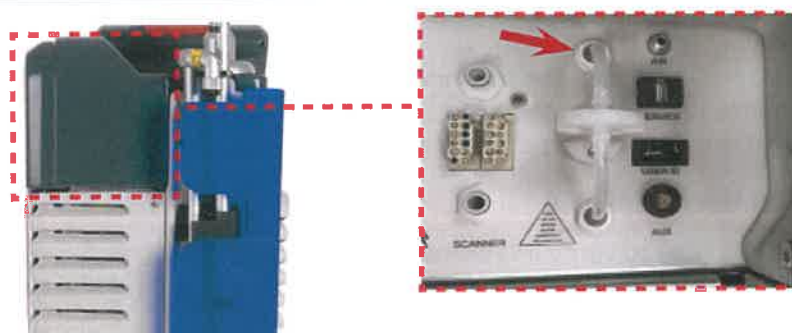

12.1.8. Air filters cleaning

This operation has to be performed once requested by the system.

The filters are located in a proper housing in the bottom rear side of the system: pull out the housing as shown in Fig. 62 and remove the protection grid.

Blow away the dust on the filter, then put it back. These filters are washable: **be sure they are completely dry before putting them back**. Replace the filters, if necessary.



CAUTION- Possible risk for patient/operator

Always disconnect the system from the mains before cleaning.



Fig.62 - Air filters replacing

12.1.9. Emergency switch and interlock

Check the correct working of the emergency switch and of the interlock network once a month.

12.2. Disposal of system

If you wish to dispose of this product, please do so in accordance with applicable national legislation or other rules in your Country for the treatment of old electrical and electronic equipment.

By disposing of this product correctly you will help to conserve natural resources and will help prevent potential negative effects on the environment and human health which could otherwise be caused by inappropriate waste handling of this product.

NOTE

The fiber optic has a plastic sheath. The damaged fiber optics should be disposed according to national and local regulations.

12.3. Maintenance to be carried out by skilled personnel

The following maintenance procedures should be performed in order to assure system reliability:

- laser source inspection;
- footswitch/shutter check;
- internal power meter inspection and calibration;
- check of the electric insulation.
- check of the cooling circuit.

The cooling fluid of the SmartXide²TRIO system is bidistilled water.

All these maintenance procedures should be carried out at least once per year by qualified personnel authorized by DEKA M.E.L.A. s.r.l..

Page intentionally left blank.

13. ACCESSORIES

SmartXide²TRIO is provided with the accessories listed in the following table:

Table 19 - Accessories

| Name | Code | Quantity |
|---|--|------------------------|
| Interlock connector | N21901 | 1 |
| Footswitch | E094B1 E06301 (optional) | 1 |
| System key | 041400050 | 2 |
| Mains cable | 021300052 | 1 |
| Door safety labels | 079102975 | 2 |
| Operator's Manual | See code on the cover | 1 |
| CO ₂ laser safety glasses for physician | 070100077 | 2 |
| Aiming beam protective eyewear | 070100078 | 2 |
| Laser safety eyewear for patient | 070100054 | 1 |
| CO ₂ laser safety glasses for physician | 070100047 | optional |
| Aiming beam protective eyewear | 070100056 | optional for 070100047 |
| Flexible hose for smoke evacuator | 070500027 | 1 |
| Smoke evacuator accessories kit | 070500028 | 1 |
| "USER ID" chip | iButton | 1 |
| Air filters | 020601021 | 2 |
| 5mm Allen wrench | 041100082 | 1 |
| Brush for cleaning | 031001153 | 3 |
| Accessories case | 070400110 | 1 |
| Low temperature recorder | 030600866 | 1 |
| Antibacterial filter set | — | 1 |
| CO ₂ fiber pole | 04364170A | 1 |
| CO ₂ fiber holder | 04244152B | 1 |
| Fiber pole passing hole | 04244070A | 1 |
| 1.5" handpiece <i>including</i> 1.5" focal assembly Handpiece body Spacer Handpiece case | F26301 N76601 N77101 04370010B 070400108 | optional |

ACCESSORIES

SmartXide² TRIO

| | | |
|---|---|----------|
| 2" handpiece <i>including</i> 2" focal assembly Handpiece body Spacer Handpiece case | F26401 N76701 N77101 04370010B 070400108 | optional |
| 4" handpiece <i>including</i> 4" focal assembly Handpiece body Spacer Handpiece case | F26501 N76801 N77101 04370012A 070400108 | optional |
| 5" handpiece <i>including</i> 5" focal assembly Handpiece body Straight spacer Spacer with backstop 90° spacer 120° spacer Handpiece case | F28001 N77801 N78001 04370017A 04370018A N83101 N83001 070400120 | optional |
| 7" handpiece <i>including</i> 7" focal assembly Handpiece body Spacer Handpiece case | F26601 N76901 N77101 04370012A 070400108 | optional |
| 8" handpiece <i>including</i> 8" focal assembly Handpiece body Straight spacer Spacer with backstop Handpiece case | F28101 N77901 N78401 04370022A 04370023A 070400121 | optional |
| Collimated handpiece <i>including</i> Collimated focal assembly Handpiece body Spacer Handpiece case | F26701 N77001 N77101 04370012A 070400108 | optional |
| HiScan Surgical unit <i>including</i> HiScan Surgical head HiScan cable Remote control | F27001 E165A1 N74801 N64501 | optional |
| EndoScan unit <i>including</i> EndoScan Cable N64501 | F26801 N77501 N74901 N64501 | optional |
| Micromanipulator EasySpot Hybrid | N183F1 | optional |
| Diode laser module at 980nm | F26201 | optional |
| Diode laser module at 940nm | F262A1 | optional |

| | | |
|--|--|--|
| 2" dental handpiece for CO ₂ source <i>including</i> 120° aperture straight aperture | N37701 N666A1 04255038B | optional |
| Endonasal probes kit 86mm <i>including</i> Handpiece for endonasal probes Hollow flexible waveguide 86mm Straight endonasal probe 86mm 90° endonasal probe 86mm Brush for probe internal cleaning Brush for probe external cleaning | F27901 N34601 N76501 04283016A 04283018B 031001152 031001153 | optional 1 2 2 2 1 3 |
| Accessories for laparoscopy: 400mm focal for laparoscope 300mm focal for laparoscope Connection for STORZ laparoscope* | N759A1 N75901 04366004A | optional |
| 500 µm hollow waveguide | – | optional |
| 60 mm Straight Handpiece | – | optional |
| 60 mm Bend Handpiece | – | optional |
| 130 mm Straight Handpiece | – | optional |
| 130 mm Bend Handpiece | – | optional |
| 180 mm Straight Handpiece | – | optional |
| 190 mm Bend Handpiece | – | optional |
| 190 mm Dbl Bend Handpiece | – | optional |
| 240 mm Straight Handpiece | – | optional |
| 230 mm Bend Handpiece | – | optional |
| 240 mm Dbl Bend Handpiece | – | optional |
| 290 mm Straight Handpiece | – | optional |

*For other laparoscope models, please ask to the laparoscope's Manufacturer or to DEKA.

For other accessories, please contact your DEKA dealer or DEKA directly.

ACCESSORIES**SmartXide² TRIO****Table 20 - F26201 diode laser accessories (if included)**

| Name | Code | Quantity |
|--|-------------|-----------------|
| 50W diode laser module at 980nm | N74601 | 1 |
| Diode laser safety glasses for physician | 070100064 | 2 |
| Diode handpiece | N10101 | 1 |
| Fiber cutter | 070001050 | 1 |
| Fiber stripper | 070001049 | 1 |
| Fiber pole and handpiece holder | N50001 | 1 |
| Fiber pole passing hole | 04244070A | 1 |

Table 21 - F262A1 diode laser accessories (if included)

| Name | Code | Quantity |
|--|-------------|-----------------|
| 50W diode laser module at 940nm | N746A1 | 1 |
| Diode laser safety glasses for physician | 070100064 | 2 |
| Diode handpiece | N10101 | 1 |
| Fiber cutter | 070001050 | 1 |
| Fiber stripper | 070001049 | 1 |
| Fiber pole and handpiece holder | N50001 | 1 |
| Fiber pole passing hole | 04244070A | 1 |

Table 22 - Optional accessories for diode laser module

| Name | Code | Quantity |
|------------------------------------|-------------|-----------------|
| 1.4*100mm cannula | 04300024B | optional |
| 1.4*150mm cannula | 04300022B | optional |
| 1.4*200mm cannula | 04300025B | optional |
| 1.4*250mm cannula | 04300023B | optional |
| 200µm fiber | 070200215 | optional |
| 200µm fiber reusable | 070200216 | optional |
| 300µm fiber | 070200217 | optional |
| 300µm fiber reusable | 070200218 | optional |
| 600µm fiber | 070200219 | optional |
| 600µm fiber reusable | 070200220 | optional |
| Dental handpiece | 04259002C | optional |
| 30° tip for 200µm-300µm fiber | 04300006B | optional |
| straight tip for 200µm-300µm fiber | 04300007B | optional |
| 30° tip for 600µm fiber | 04300010B | optional |
| straight tip for 600µm fiber | 04300014B | optional |

14. APPENDIX A

| GUIDANCE AND MANUFACTURER'S DECLARATION - ELECTROMAGNETIC EMISSION | |
|--|-------------------|
| <p>The SmartXide²TRIO system is intended for use in PROFESSIONAL HEALTHCARE ENVIRONMENT. The customer or the user of the SmartXide²TRIO system should assure that it is used in such an environment.</p> | |
| Emission Test | Compliance |
| RF Emissions CISPR 11 | Group 1 |
| RF Emissions CISPR 11 | Class B |
| Harmonic Emissions IEC 61000-3-2 | NA* |
| Voltage fluctuation/ flicker emissions IEC 61000-3-3 | Complies |

* Professional use P>1kW

| GUIDANCE AND MANUFACTURER'S DECLARATION - ELECTROMAGNETIC IMMUNITY | |
|---|---|
| <p>The SmartXide² TRIO system is intended for use in PROFESSIONAL HEALTHCARE ENVIRONMENT. The customer or the user of the SmartXide²TRIO system should assure that it is used in such an environment.</p> | |
| Immunity test | Test level IEC 60601-1-2/ Compliance level |
| Electrostatic discharge (ESD) IEC 61000-4-2 | ±8kV contact ±15kV air |
| Electrical fast transient/burst IEC 61000-4-4 | ±2kV 100kHz repetition frequency |
| Surge IEC 61000-4-5 | ±1kV differential mode ±2kV common mode |
| Voltage dips, Voltage interruptions IEC 61000-4-11 | <p>UT=0%, 0.5 cycle (0, 45, 135, 180, 225, 270 and 315°)</p> <p>UT=0%; 1 cycle and UT=70%; 25/30 cycles, single phase: at 0°</p> <p>UT=0%; 250/300 cycles</p> |
| Power frequency (50 or 60Hz) magnetic field IEC 61000-4-8 | 30A/m |

| GUIDANCE AND MANUFACTURER'S DECLARATION - ELECTROMAGNETIC IMMUNITY | | | |
|--|--|--|--|
| The SmartXide ² TRIO system is intended for use in PROFESSIONAL HEALTHCARE ENVIRONMENT. | | | |
| Immunity test | Test level IEC 60601-1-2 / Compliance level | | |
| Conducted RF IEC 61000-4-6 | 3V _{RMS} 150kHz÷80MHz 6V _{RMS} ISM Bands | WARNING: Portable RF communications equipment (including peripherals such as antenna cables and external antennas) should be used no closer than 30 cm (12 inches) to any part of the SmartXide ² TRIO including cables specified by the manufacturer. Otherwise, degradation of the performance of this equipment could result. | |
| Radiated RF IEC 61000-4-3 | 3V/m 80MHz÷2.7GHz | WARNING: Portable RF communications equipment (including peripherals such as antenna cables and external antennas) should be used no closer than 30 cm (12 inches) to any part of the SmartXide ² TRIO, including cables specified by the manufacturer. Otherwise, degradation of the performance of this equipment could result. | |
| Proximity field from wireless transmitters IEC 61000-4-3 | Test frequency [MHz] | Immunity test level [V/m] | WARNING: Portable RF communications equipment (including peripherals such as antenna cables and external antennas) should be used no closer than 30 cm (12 inches) to any part of the SmartXide ² TRIO, including cables specified by the manufacturer. Otherwise, degradation of the performance of this equipment could result. |
| | 385 | 27 | |
| | 450 | 28 | |
| | 710 | 9 | |
| | 745 | | |
| | 780 | | |
| | 810 | 28 | |
| | 870 | | |
| | 930 | | |
| | 1720 | 28 | |
| | 1845 | | |
| | 1970 | | |
| | 2450 | 28 | |
| | 5240 | 9 | |
| 5500 | | | |
| 5785 | | | |

| CABLES AND ACCESSORIES WITH WHICH COMPLIANCE TO IEC 60601-1-2 EMC REQUIREMENTS IS CLAIMED | |
|--|-----------|
| Interlock connector | N21901 |
| Foot switch | E094B1 |
| Mains cable | 021300052 |
| 1.5" handpiece | F26301 |
| 2" handpiece | F26401 |
| 4" handpiece | F26501 |
| 5" handpiece | F28001 |
| 7" handpiece | F26601 |
| 8" handpiece | F28101 |
| Collimated handpiece | F26701 |
| HiScan Surgical cable | N74801 |
| EndoScan cable | N74901 |
| Diode laser module at 980nm | N74601 |
| Diode laser module at 940nm | N746A1 |
| 500 µm hollow waveguide | — |
| Micromanipulator | N183F1 |

CAUTION: Use of accessories, transducers, and cables other than those specified or provided by the manufacturer of this equipment could result in increased electromagnetic emissions or decreased electromagnetic immunity of this equipment and result in improper operation. Contact DEKA M.E.L.A. s.r.l. for approved replacement parts.

15. APPENDIX B

CAUTION!

The following procedures should only be done by trained personnel authorized by Deka. When the system enclosure is removed, hazardous voltages and/or laser radiation levels are exposed.

15.1. Internal power meter calibration

The SmartXide² TRIO system is equipped with an internal power meter that allows the microprocessor to detect the real output power level generated by the CO₂ laser source. The signal from this power meter is first processed by the hardware on the CPU board before being read and converted by the A/C converter located inside the microcontroller.

Please contact the Manufacturer to arrange for an annual calibration.

The calibrating procedure is here described just for information:

1. Enter the SERVICE menu, set "calib OFF" and check that the offset value between TP1 (GND) and N10-7 $\leq 13\text{mV}$
 2. Set 30W CW and measure the output power from the articulated arm: if needed, act on the Ton value in order to obtain the requested power level $27\text{W} < P_{\text{meter}} < 33\text{W}$
 3. Regulate RP1 (GAIN) up to make the internal power meter read the same power of the external one $\pm 0.2\text{W}$
 4. Preregulate RV1 (SPEED UP) up to make the internal power meter read the right power in 3s, without overshoot.
 5. Set 0.5W CW and measure the output power from the handpiece: if needed act on the DAC value in order to obtain the requested power level $0.4\text{W} < P_{\text{meter}} < 0.6\text{W}$
 6. Regulate RP3 (GAIN) up to make the internal power meter read the same power of the external one $\pm 0.02\text{W}$
 7. Check the power meter calibration in the following sets:
 - $P_{\text{ext}} = \text{CW } 4.5\text{W}$
 - $P_{\text{ext}} = \text{CW } 10\text{W}$
 - $P_{\text{ext}} = 60\text{W}$
 and verify respectively that:
 - $4.05\text{W} < P_{\text{int}} < 4.95\text{W}$
 - $9.5\text{W} < P_{\text{int}} < 10.5\text{W}$
 - $54\text{W} < P_{\text{int}} < 66\text{W}$
- If the measured values are out of the requested range, repeat the operations from step 3.
8. Set Calib On and check in UP mode that the Ton value to have the output power in the range indicated below:
 - $T_{\text{on}_{40\text{W}}} \leq 750\mu\text{s}$
 9. Perform reset.

Page intentionally left blank.

DEKA
Innate Ability

DEKA M.E.L.A. s.r.l.
Via Baldanzese, 17
50041 Calenzano (FI) - Italy
Ph. +39 055 88.74.942
Fax +39 055 88.32.884



www.dekalaser.com